

ORA GWM



Thank you for choosing GWM - ORA.

The more familiar you become with your vehicle, the more you will like it and the better you will be able to use its features. Therefore, we ask you the following:

Please read this manual carefully before driving your vehicle. There are important tips about using your vehicle in this booklet that will help you make the best use of your vehicle's technology. Additionally, you will learn very practical information about driving safety, road safety and maintaining the value of your vehicle.

May you enjoy safe and happy travels!

Overview

Contains a statement about the use of the manual and the meaning of the symbols.

Vehicle equipment

Please note that this manual describes all standard equipment, country-specific equipment and special equipment for this series. Therefore, some equipment or functions described in this manual may not be installed in your vehicle or only available in certain markets. To learn more about specific configurations, please refer to sales documents or consult the dealer where you purchased the vehicle.

On right-hand drive vehicles, the actual positions of some operating elements may be different from those shown in the illustrations.

Validity of this manual

This manual has the latest information available at the time it was released. However, as our products continue to improve, the topics in this manual will have updated information. Use the vehicle's multimedia display to find the latest digital owner's manual.

Depending on the vehicle specifications, the vehicle equipment shown in pictures may be different from your vehicle.

The screen display information (such as pictures, icons and text) shown in this manual is for illustrative purposes only. Depending on the vehicle configuration, software version, theme and settings,

the information displayed may be different. Please refer to the actual model for specific information.

Accessories, replacement parts and modifications

Both genuine parts and various other spare parts and accessories suitable for this vehicle are available for purchase. We recommend using genuine parts or other parts that comply with quality standards for all replacements.

We are unable to provide any guarantee and assume no responsibility and obligation for non-genuine parts and accessories or for using non-genuine spare parts and accessories for replacement or installation. Moreover, any damage to the vehicle or performance issue caused by the use of a non-genuine part or accessory is not covered by the warranty.

Symbols

WARNING

This represents a warning. Ignoring these warnings may result in serious injury or death. These warnings inform you what you must or must not do to reduce the risk of serious injury and death to yourself and others.

CAUTION

This represents a precaution.

Ignoring these precautions may result in damage to the vehicle or equipment. These precautions inform you what you must or must not do to avoid or reduce the risk of damage to the vehicle or equipment.

NOTICE

This represents a notice.

This type of supplementary information may be helpful to you.

Safety notice

WARNING

General precautions for driving

- › Sober driving: Alcohol, drugs, anaesthetics and some medicines slow down the body's reactions and affect judgement and coordination, which can easily result in loss of control over the vehicle and a serious accident.
- › Drive carefully: Always pay attention to mistakes that other drivers or pedestrians on the road may make, so you can promptly appraise the situation and prevent an accident.
- › Pay attention while driving: Anything that distracts the driver, including adjusting vehicle controls, making or receiving telephone calls and reading can cause a collision that results in serious injury or death to you, passengers in the vehicle or others.

WARNING

Never leave a child, a person needing assistance or a pet alone in the vehicle.

- › Children, people needing assistance and pets cannot leave the vehicle or rescue themselves. The temperature inside the vehicle may become very high or very low in certain weather conditions, which can easily lead to injury or even death.
- › If a child or pet touches the key, this may start the vehicle, release the parking brake, switch the gear position, operate the doors or windows or cause the vehicle to move on its own, endangering the vehicle and surrounding traffic and pedestrians.

Exterior (Type I)

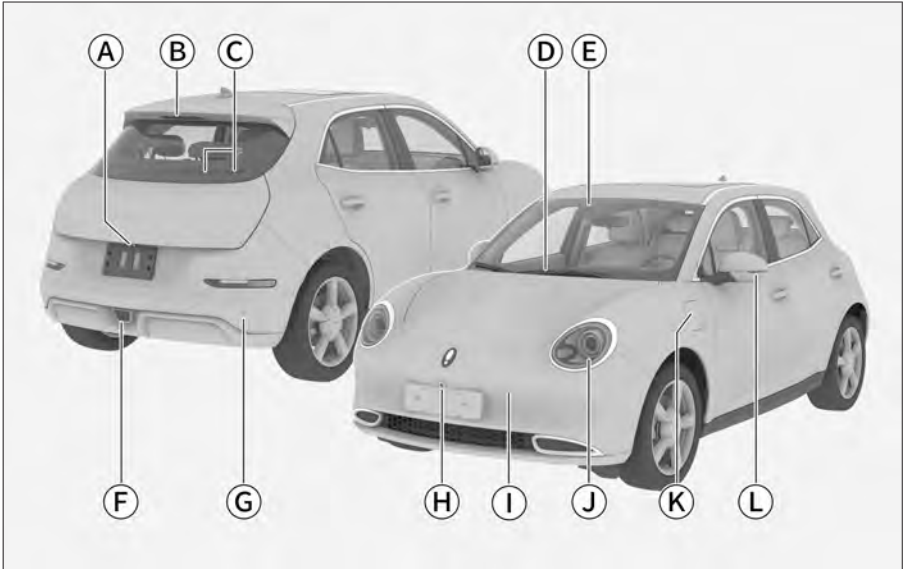

79B86D2AFCB3

- Ⓐ Camera, for:
Panoramic view [113](#)
- Ⓑ High position brake light
- Ⓒ Rear lights assembly
- Ⓓ Automatic front wipers [63](#)
- Ⓔ Depending on the model configuration, the camera may be used for:
Lane assist system [134](#)
Forward assist system [129](#)
Traffic sign information [138](#)
- Ⓕ Rear fog lamp [58](#)
- Ⓖ Anti-collision radar [114](#)
- Ⓗ Camera, for:
Panoramic view [113](#)
- Ⓘ Anti-collision radar [114](#)
- ⓵ Front lights assembly
- ⓶ Charging port cover [40](#)
- ⓷ Side mirrors [53](#)

Exterior (type II)

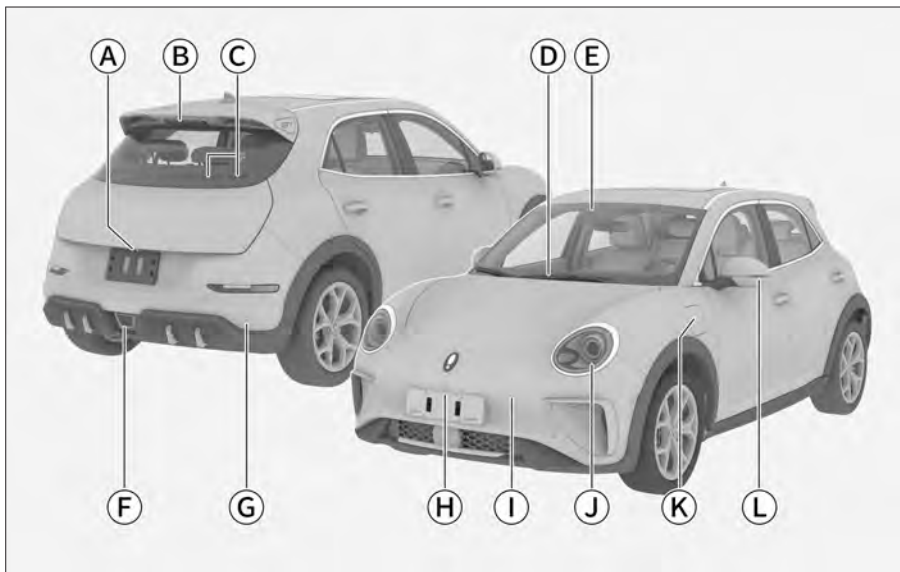

57B924118940

- Ⓐ Camera, for:
 - Panoramic view [113](#)
- Ⓑ High position brake light
- Ⓒ Rear lights assembly
- Ⓓ Automatic front wipers [63](#)
- Ⓔ Depending on the model configuration, the camera may be used for:
 - Lane assist system [134](#)
 - Forward assist system [129](#)
 - Traffic sign information [138](#)
- Ⓕ Rear fog lamp [58](#)
- Ⓖ Anti-collision radar [114](#)
- Ⓗ Camera, for:
 - Panoramic view [113](#)
- Ⓘ Anti-collision radar [114](#)
- Ⓙ Front lights assembly
- Ⓚ Charging port cover [40](#)
- Ⓛ Side mirrors [53](#)

Interior - left-hand drive

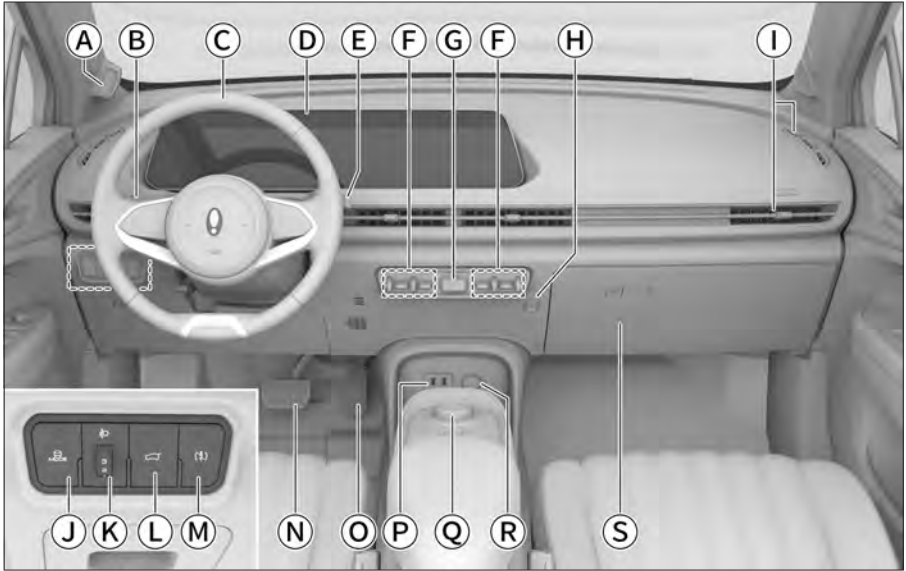

F843E817A78C

- Ⓐ Camera used for intelligent monitoring system [121](#)
- Ⓑ Lighting control combination switch [58](#)
- Ⓒ Steering wheel [56](#)
- Ⓓ Display screen, for:
 - Virtual instruments panel [144](#)
 - Instruments panel lights [148](#)
 - Multimedia [164](#)
- Ⓔ Wiper control combination switch [63](#)
- Ⓕ A/C control switch [66](#)
- Ⓖ Hazard warning light switch [60](#)
- Ⓗ Luggage hook
- Ⓘ A/C outlet vent [71](#)
- Ⓙ Driving mode switch [106](#)
- Ⓚ Headlamp levelling switch [61](#)
- Ⓛ Boot lid control switch [24](#)
- Ⓜ Vehicle power supply off button [97](#)
- Ⓝ Brake pedal
- Ⓞ Accelerator pedal
- Ⓟ USB port [161](#)
- Ⓠ Gear change twist knob [102](#)
- Ⓡ Backup power supply [76](#)
- Ⓢ Glove box [74](#)

Interior - right-hand drive

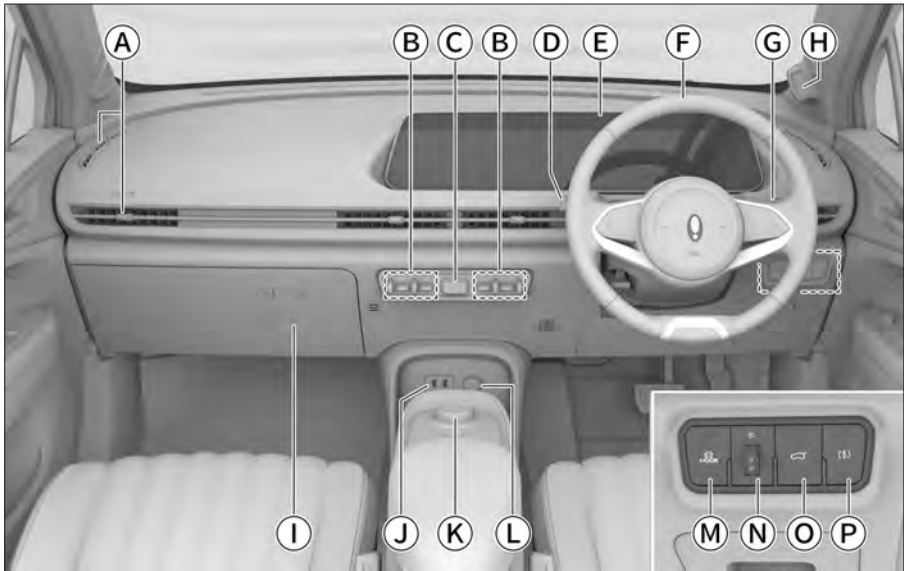

B65B38A7777B

- Ⓐ A/C outlet vent [71](#)
- Ⓑ A/C control switch [66](#)
- Ⓒ Hazard warning light switch [60](#)
- Ⓓ Lighting control combination switch [58](#)
- Ⓔ Display screen, for:
 - Virtual instruments panel [144](#)
 - Instruments panel lights [148](#)
 - Multimedia [164](#)
- Ⓕ Steering wheel [56](#)
- Ⓖ Wiper control combination switch [63](#)
- Ⓗ Camera used for intelligent monitoring system [121](#)
- Ⓘ Glove box [74](#)
- Ⓙ USB port [161](#)
- Ⓚ Gear change twist knob [102](#)
- Ⓛ Backup power supply [76](#)
- Ⓜ Driving mode switch [106](#)
- Ⓝ Headlamp levelling switch [61](#)
- Ⓞ Boot lid control switch [24](#)
- Ⓟ Vehicle power supply off button [97](#)

Contents

| | |
|-----------------------|---|
| 1 Operation | Explains the basic functions of interior equipment such as the key, doors, windows and seats. |
| 2 Driving | Provides information about starting the vehicle, changing gear, the instrument panel and other driving-related items. |
| 3 Audio-visual system | Explains the functions of the audio-visual system such as making calls using Bluetooth and system settings. |
| 4 Safety & Security | Describes vehicle safety devices such as the anti-theft system and seat belts. |
| 5 Emergency | Explains how to deal with a vehicle failure such as a burst tyre or flat battery. |
| 6 Maintenance | Explains daily inspections and regular maintenance. |
| 7 Technical data | Describes information such as vehicle specifications and the vehicle identification number. |
| 8 Index | List of the alphabetical index in this manual. |

Operation

| | | | |
|--|----|--|----|
| Key | 18 | Sunroof operation | 34 |
| Information about the key..... | 18 | Closing and opening the sunshade | 35 |
| Button introduction..... | 18 | Linked function | 35 |
| Battery replacement..... | 19 | Anti-trapping function | 35 |
| Door locks..... | 21 | Delay function | 36 |
| Intelligent entry system locking and | 21 | Easy close | 36 |
| unlocking..... | 21 | Automatic closing function..... | 36 |
| Key button locking and unlocking | 22 | Initialisation | 36 |
| | 22 | Bonnet..... | 38 |
| Central locking and unlocking..... | 22 | Opening..... | 38 |
| Mechanical key locking and unlock- | 22 | Closing..... | 38 |
| ing..... | 22 | Vehicle charging..... | 40 |
| Internal release unlocking | 23 | Charging mode..... | 40 |
| Super lock | 23 | Charging cable..... | 41 |
| Emergency locking..... | 23 | Normal charging | 42 |
| Boot lid | 24 | Emergency release | 45 |
| Child lock..... | 29 | Fast charging | 45 |
| Parking unlocking | 29 | Seats | 46 |
| Auto lock | 29 | Headrests..... | 46 |
| Automatic relock..... | 30 | Front row manual seats..... | 46 |
| Collision auto-unlock..... | 30 | Front row electric seats..... | 48 |
| Windows | 31 | Rear row seat adjustment | 48 |
| Window switch | 31 | Easy entry function..... | 49 |
| Heat protection function | 32 | Driver's seat memory..... | 49 |
| Anti-trapping function..... | 32 | Seat settings | 51 |
| Delay function | 32 | Mirrors..... | 53 |
| Easy close | 32 | Rear view mirror | 53 |
| Initialisation | 33 | Side mirror adjustment..... | 53 |
| Sunroof..... | 34 | Side mirror settings | 54 |

| | |
|---|----|
| Side mirror defrosting function | 55 |
| Steering wheel..... | 56 |
| Adjustment method | 56 |
| Horn..... | 56 |
| Heating function | 57 |
| Lighting controls | 58 |
| Lighting control combination switch | 58 |
| Hazard warning lights | 60 |
| Daytime running lights..... | 61 |
| Follow me home headlights | 61 |
| Emergency braking warning..... | 61 |
| Levelling the headlamps | 61 |
| Lighting settings | 61 |
| Interior lights | 62 |
| Wiper controls..... | 63 |
| Front wipers..... | 63 |
| Optical rain sensor | 64 |
| Windscreen washer nozzle heating function | 65 |
| Front wiper interval | 65 |
| A/C system..... | 66 |
| A/C control screen | 66 |
| A/C settings screen | 67 |
| A/C controller | 70 |
| Cabin air refresh | 71 |
| Air vents | 71 |
| Mobile phone wireless charging..... | 72 |
| Usage..... | 72 |
| Interior fittings | 74 |

| | |
|--------------------------|----|
| Sun visors..... | 74 |
| Vanity mirror..... | 74 |
| Storage | 74 |
| Power supply socket..... | 76 |

Driving

| | |
|---|----|
| Driving procedures..... | 80 |
| Before driving..... | 80 |
| While driving..... | 81 |
| Precautions for passengers..... | 83 |
| Parking the vehicle | 83 |
| Economical driving..... | 84 |
| Driving in adverse weather conditions | 85 |
| Driving in fog | 85 |
| Driving in the rain | 85 |
| Driving through water | 85 |
| Driving in hot weather..... | 86 |
| Driving in cold weather | 87 |
| Running-in | 90 |
| Tyres | 90 |
| Brake pads | 90 |
| Pure electric vehicles..... | 91 |
| Power battery recycling | 91 |
| About pure electric vehicles | 92 |
| Charger temperature regulation function | 94 |
| Energy recovery | 94 |
| Battery safety switch | 95 |
| High-voltage warning labels | 95 |
| Vehicle power supply | 97 |

| | | | |
|--|-----|---|-----|
| Vehicle power supply | 97 | Cruise control assist system | 123 |
| Parking brake | 99 | System overview | 123 |
| Safety notice | 99 | Usage | 124 |
| Electric parking brake..... | 99 | Traffic jam assist | 126 |
| Gearbox..... | 102 | Cornering assist | 126 |
| Gears | 102 | Lane centring assist while cruising | 126 |
| Changing gear | 102 | Function limits..... | 127 |
| Creep function..... | 103 | Sensors..... | 128 |
| Driving off..... | 103 | Intelligent driving assistance system | 129 |
| Park..... | 104 | Usage | 129 |
| Driving mode..... | 106 | Forward assist system..... | 129 |
| Switching modes..... | 106 | Side and rear assist system..... | 132 |
| Acoustic vehicle alert system | 109 | Lane assist system..... | 134 |
| Usage | 109 | Smart cruise..... | 137 |
| Power assisted steering mode..... | 110 | Traffic sign information..... | 138 |
| Switching modes..... | 110 | Driving assistance systems..... | 141 |
| Parking assist system | 111 | Safety notice | 141 |
| Safety notice | 111 | Anti-lock braking system..... | 141 |
| Parking settings..... | 112 | Electronic brake force distribution system | 142 |
| Panoramic view | 113 | Emergency brake assist | 142 |
| Anti-collision radar..... | 114 | Traction control system | 142 |
| Intelligent integrated parking sys- tem | 115 | Secondary collision mitigation sys- tem..... | 142 |
| Track-back reverse..... | 117 | Hill hold control..... | 142 |
| Tyre pressure monitoring system .. | 119 | Electric power steering..... | 142 |
| System overview | 119 | Electronic stability control | 142 |
| Monitoring function..... | 119 | Virtual instruments..... | 144 |
| Warnings | 119 | | |
| Intelligent monitoring system..... | 121 | | |
| Intelligent monitoring system | 121 | | |

| | |
|----------------------------------|-----|
| Overview | 144 |
| Instruments panel controls | 146 |
| Instruments panel lights..... | 148 |
| Instruments panel lights..... | 148 |
| Power management system | 155 |
| System overview | 155 |
| Things you should know | 155 |

Audio-visual system

| | |
|---|-----|
| Safety notice..... | 158 |
| Vehicle equipment..... | 158 |
| Safety..... | 158 |
| Use | 158 |
| Radio..... | 158 |
| USB storage devices | 158 |
| Bluetooth | 158 |
| Introduction to the panel | 160 |
| Vehicle equipment..... | 160 |
| Steering wheel buttons..... | 160 |
| External devices | 161 |
| Introduction to the display screen. 164 | |
| Multimedia display | 164 |
| Using the display screen..... | 164 |
| Central display status bar..... | 164 |
| Function introduction | 166 |
| Vehicle equipment..... | 166 |
| Screen overview..... | 166 |
| Shortcut screen | 167 |
| Launcher screen | 167 |
| Communication..... | 168 |

| | |
|------------------------------|-----|
| System settings | 169 |
| My account | 172 |
| Power assistant..... | 172 |
| Voice assistant..... | 172 |
| Entertainment scenario | 173 |
| Driving scenario | 174 |
| Skill tree..... | 177 |
| E-manual..... | 177 |

Safety & Security

| | |
|--|-----|
| Seat belts | 180 |
| Safety notice | 180 |
| Correctly wearing your seat belt. 181 | |
| Pre-tensioner seat belts..... | 181 |
| How to use the three-point seat belt | 182 |
| Airbags | 184 |
| Vehicle equipment..... | 184 |
| Safety notice | 184 |
| Airbags..... | 185 |
| Front airbags | 186 |
| Side airbags | 188 |
| Curtain airbags..... | 189 |
| Seat-mounted side airbags | 190 |
| Front passenger airbag switch.... | 190 |
| Child restraint system..... | 192 |
| Recommended child seat types.. | 192 |
| Child seat safety instructions..... | 193 |
| Child seat fixing points..... | 194 |
| Child seat installation | 195 |

| | |
|------------------------------------|-----|
| Complete vehicle anti-theft system | 199 |
| System description | 199 |
| Usage | 199 |
| Ultrasonic theft protection system | 201 |
| Usage | 201 |
| Vital signs monitoring | 202 |
| Function overview | 202 |
| Alarm types | 202 |
| Switching off the alarm | 203 |
| Emergency shut-off system | 204 |
| Emergency shut-off system | 204 |
| Event data recorder | 205 |
| System description | 205 |
| Data access | 205 |
| Data disclosure | 205 |
| Information security | 207 |
| Data privacy and protection | 207 |

Emergency

| | |
|--------------------------------|-----|
| Toolkit | 212 |
| Toolkit location | 212 |
| Punctures or low tyre pressure | 213 |
| Air pump and tyre repair fluid | 213 |
| Emergency tyre repair | 213 |
| Tyre inflation | 215 |
| In case of an accident | 216 |
| In case of a traffic accident | 216 |
| In case of fire | 216 |
| Jump lead connection | 218 |
| Signs of a drained battery | 218 |

| | |
|---|-----|
| Starting with jump leads | 218 |
| Towing | 220 |
| Using a specialised vehicle for transport | 220 |
| If the vehicle gets stuck or high-centred | 220 |
| Tow rope | 221 |
| Towing hook | 222 |
| Services and recovery | 224 |
| Function introduction | 224 |

Maintenance

| | |
|---|-----|
| The importance of vehicle care | 228 |
| Engine compartment | 229 |
| Safety notice | 229 |
| Location of oil and fluids | 229 |
| Brake fluid | 230 |
| Coolant | 230 |
| Windscreen washer fluid | 231 |
| Active intake grille | 231 |
| Battery | 231 |
| Safety stickers and labels | 232 |
| Engine compartment warning sticker | 232 |
| Warm air system overflow tank warning label | 232 |
| Powertrain system overflow tank warning label | 232 |
| Battery warning symbol | 233 |
| Replacing components | 234 |
| Fuses | 234 |

| | |
|---|-----|
| Wiper blades..... | 235 |
| Bulbs..... | 237 |
| Vehicle care | 238 |
| Tyre care..... | 238 |
| Sunroof care | 240 |
| Exterior maintenance..... | 241 |
| Interior care | 242 |
| Anti-corrosion measures | 243 |
| Long term vehicle storage | 244 |
| Environmental information..... | 246 |
| Disposal of batteries and electronic equipment | 246 |
| Vehicle recycling and scrapping.. | 246 |

Technical data

| | |
|-------------------------------------|-----|
| Vehicle identification..... | 248 |
| Vehicle identification number | 248 |
| Drive motor serial no. | 249 |
| Vehicle parameters | 250 |
| Basic parameters | 250 |
| Powertrain parameters..... | 250 |
| Tyre specification | 251 |
| Wheel parameters | 251 |
| Brake parameters..... | 251 |
| Oil and fluid parameters..... | 252 |
| Seat parameters..... | 252 |

Index

| | |
|--------------------------|-----|
| Alphabetical index | 254 |
|--------------------------|-----|

1

Operation

| | |
|---|----|
| Key | 18 |
| Door locks..... | 21 |
| Windows | 31 |
| Sunroof | 34 |
| Bonnet..... | 38 |
| Vehicle charging..... | 40 |
| Seats | 46 |
| Mirrors | 53 |
| Steering wheel | 56 |
| Lighting controls | 58 |
| Wiper controls..... | 63 |
| A/C system..... | 66 |
| Mobile phone wireless charging | 72 |
| Interior fittings | 74 |

Vehicle equipment

Please note that this manual describes all standard equipment, country-specific equipment and special equipment for this series. Therefore, some equipment or functions described in this manual may not be installed in your vehicle or only available in certain markets. To learn more about specific configurations, please refer to sales documents or consult the dealer where you purchased the vehicle.

Information about the key

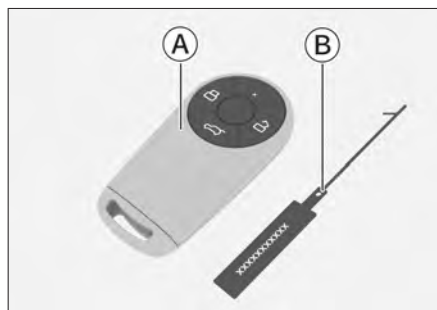

4357ACCB665C

- Ⓐ Smart key
- Ⓑ Key number plate

i NOTICE

- › Please keep track of the key number plate. The code on the plate is required to make a replacement key. You will need this code to ask an authorised service centre to make a replacement key.
- › This number must be given to the owner when buying or leasing the vehicle.

Button introduction

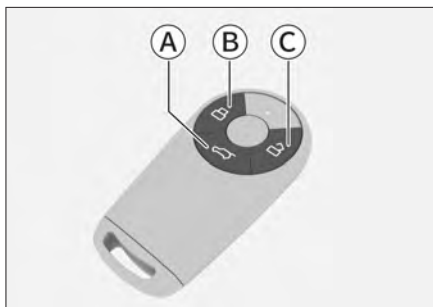

580544CE25D5

- Ⓐ Boot lid control button
- Ⓑ Lock button
- Ⓒ Unlock button

Lock button

Press the lock button to lock all doors. The indicators will blink once.

i NOTICE

If the indicators do not flash when locking the doors, check that all doors and the boot lid are fully closed.

Unlock button

Press the unlock button to unlock all doors. The indicators will blink twice.

- › You can set the unlocking mode in **【Vehicle Settings】** → **【Body】** → **【Door Lock】** via the multimedia screen.

If it is set to **【Driver Only】**, when the unlock button is pressed, only the driver's door will be unlocked. At that point, if the unlock button is pressed again, all doors will be unlocked.

If it is set to **【Four Doors Unlock】**,

when you press the unlock button, all doors will be unlocked.

Boot lid control button

When the power supply mode is OFF, the boot lid can be unlocked by pressing and holding the boot lid control button. After unlocking, press the boot lid micro switch within 30 seconds to open the boot lid. For an electric sensor boot lid, pressing and holding the boot lid control button will open or close the electric sensor boot lid.

Car search

When all the doors and the boot lid are locked and the anti-theft system is on, press the lock button twice to turn on car search function to quickly find your vehicle in car parks and other places. Pressing the lock button again will switch off the search function.

NOTICE

Go to **【Vehicle Settings】** → **【Lighting】** → **【Parked Car Alert Mode】** on the multimedia display to set the vehicle alert status when car search is triggered.

CAUTION

- › You must not change the transmitting frequency or increase the transmitting power rating (including by adding a radio-frequency power amplifier) and must not connect an external antenna or adapt any other

aerial.

- › Your usage must not interfere with any legal radio communications operation. If any interference occurs, usage should be stopped and measures taken to eliminate the interference before usage continues.
- › Usage may be affected by various radio devices, causing brief interruptions in function.

Battery replacement

WARNING

The vehicle key contains a button battery.

- › The button battery built into the vehicle key is dangerous. Both new and old batteries must be kept away from children at all times.
- › If swallowed or inserted into any part of the body, the button battery can cause severe or fatal injury within two hours or less.
- › If it is suspected that the battery has been swallowed or that it has been inserted into any part of the body, seek immediate medical attention.
- › Dispose of used batteries in accordance with local laws. Incorrect disposal of used batteries may cause environmental damage.

CAUTION

- › During this operation, be sure to

wipe both hands dry as moisture may rust the battery.

- › Do not touch or interfere with any other parts.
- › The positive and negative poles of the battery must be fitted correctly.
- › When changing batteries, take care not to lose components.

1. Press the release button of the smart key to remove the mechanical key.

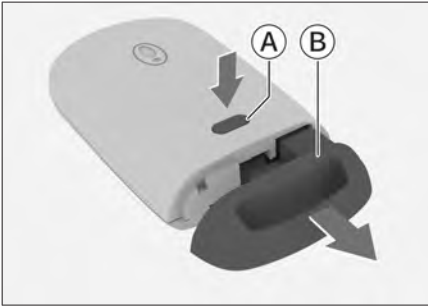

8CC014F2D82A

- Ⓐ Release button
- Ⓑ Mechanical key

2. Using a flat-headed screwdriver, gently pry open the back cover of the key and remove it.

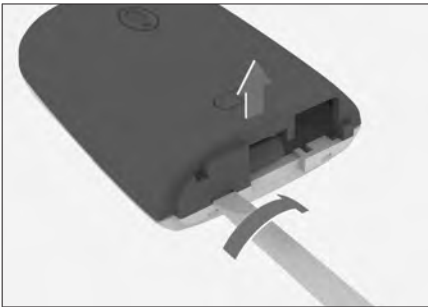

EF6BBD1493D6

3. Remove the old battery and install the new battery into the recess.



B32C065C97FD

Install the battery with the positive pole facing up.

Battery model: CR2032

4. Replace the key back cover.

After installing, verify that the key buttons are working properly.

Vehicle equipment

Please note that this manual describes all standard equipment, country-specific equipment and special equipment for this series. Therefore, some equipment or functions described in this manual may not be installed in your vehicle or only available in certain markets. To learn more about specific configurations, please refer to sales documents or consult the dealer where you purchased the vehicle.

Intelligent entry system locking and unlocking

When carrying the smart key, you can use the intelligent entry system to lock and unlock the doors.

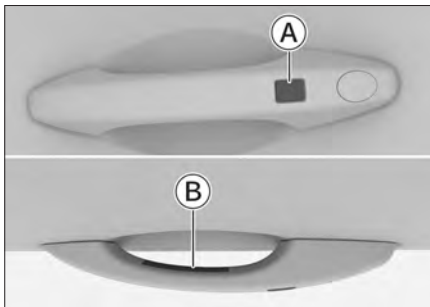

F29E2FDB3304

- Ⓐ Locking sensor
- Ⓑ Unlocking sensor

Unlocking operation

Touching the unlocking sensor unlocks all doors. The indicators will blink twice.

i NOTICE

- › You can set the unlocking mode in **【Vehicle Settings】** → **【Body】** →

【Door Lock】 via the multimedia screen.

If it is set to **【Driver Only】**, when the unlock button is pressed, only the driver's door will be unlocked. At that point, if the unlock button is pressed again, all doors will be unlocked.

If it is set to **【Four Doors Unlock】**, when you press the unlock button, all doors will be unlocked.

Locking operation

Touch the locking sensor to lock all doors. The indicators will blink once.

i NOTICE

If the indicators do not flash when the door lid is locked, check that all doors and the boot are fully closed.

i NOTICE

- › You can only operate doors which can detect the smart key.
- › Do not lock and unlock at the same time.
- › If you wear gloves when you operate the door handle, you may not be able to unlock or lock the door.
- › The wireless signal of the intelligent entry system is relatively weak. When there are other wireless devices in the vicinity or the device is covered by an obstruction, the communication between the smart key and the

vehicle may be affected, leading to the system not working properly.

- › After the locking or unlocking sensor are used successfully to lock or unlock the doors, the locking or unlocking sensor stops working for 3 seconds.

Key button locking and unlocking

See the key button introduction.

(▷ Page 18)

Central locking and unlocking

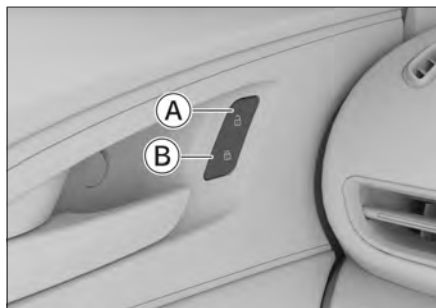

E8490CFC15F4

- (A) Unlock button
- (B) Lock button

The central locking/unlocking button is located on the driver's door. Press it to lock or unlock all doors.

Mechanical key locking and unlocking

1. Pull up the door handle and push the protective cover from the inside to remove it.



4B74D7E38AD4

2. Insert the mechanical key into the door lock. Rotating it locks or unlocks the door.

For the location of the mechanical key, see key battery replacement.

(▷ Page 19)

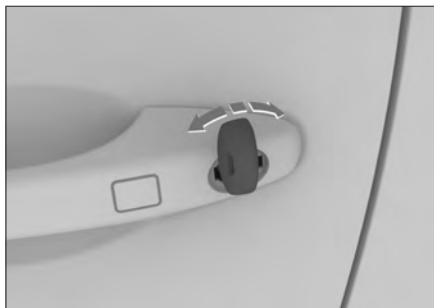

054AFBC63079

⚠ CAUTION

After the door is unlocked, the mechanical key must be removed before opening the driver's side door.

i NOTICE

Using the mechanical key to unlock the doors may trigger the vehicle anti-theft alarm. (▷ Page 199)

Internal release unlocking



A93DD9958A21

With the doors locked, pull the interior door release to unlock the door, and pull it again to open the door.

i NOTICE

When opening the door with the internal release, make sure that the child lock is in the off state, otherwise the rear doors cannot be opened.

Super lock

On vehicles equipped with super locks, go to **【Vehicle Settings】** → **【Body】** → **【Door Lock】** on the multimedia display to turn the super locks on or off.

After the super lock is activated and the vehicle is locked from outside, the door cannot be opened using the interior handle, and only the smart key or the mechanical key can unlock and open the

door.

! WARNING

If the vehicle is occupied and the vehicle has to be locked from the outside, make sure to deactivate the super lock to avoid locking someone inside the vehicle.

Emergency locking



C58BC19DE96E

The front passenger door and rear doors are equipped with emergency door locks.

As in the diagram, insert the mechanical key into the slot in the emergency lock hole, pull it to the lowest position, and then close the door to lock the door.

i NOTICE

When you need to use this method to lock the doors, it means the electric door lock system has a fault. Please go to an authorised service centre as soon as possible for repair.

Boot lid

Boot lid - manual

Open



E03AF5037DFC

- › When carrying the smart key, press the boot lid micro switch and lift at the same time.
- › When the power supply mode is OFF, press and hold the boot lid control button on the key. Within 30 seconds, press the boot lid micro switch and lift at the same time.
- › When the driver's door is unlocked, open the boot lid at the same time as pressing the boot lid micro switch.

Close



57BC139F67D1

1. Pull down on the hand grip inside the boot lid, but let go of the grip before

the boot lid closes completely.

2. Push down on the boot lid from outside to close it completely.

! WARNING

- › When closing the boot lid manually, be sure to push on the boot lid from outside the vehicle to fully close it. If you only use the hand grip to close the boot lid directly, it is easy to trap your hand, and this could cause an injury.
- › Driving the vehicle with the boot lid open is prohibited.
- › It is prohibited to carry passengers in the luggage area.
- › If there are other people in the vicinity of the boot lid, ensure that they are not hurt when opening or closing the boot.
- › When closing the boot lid, ensure that nothing you are carrying or wearing becomes trapped in the door.
- › Do not let children operate the boot lid. This could lead to an injury.

! CAUTION

- › When opening the boot lid, do not use excessive force or you may damage it.
- › Use caution when opening the boot lid in strong wind. When windy, the boot lid may open too far causing it to distort.

- › If the boot lid is frozen shut or covered with ice and snow, do not force open the boot lid. Use the A/C heating function to increase the temperature in the vehicle before opening the boot lid.

If the boot lid must be opened in an emergency, warm water may be poured on it to melt the ice. Wait until the ice has loosened before trying to open the boot lid.

- › Do not fix or stick anything onto the boot lid support rod.
- › Do not pull sideways on the boot lid, as this may result in the support bending.

i NOTICE

- › When the ambient temperature is lower than 0°C, the boot lid support may not automatically raise the boot lid. If this happens, the boot lid can be manually raised to open it.
- › Do not install heavy attachments on the boot lid, as this may cause the support to fail to hold the boot lid up.
- › The telescopic movement of the boot lid support requires oil to assist in lubrication, so there may be oil stains around the dust cover of the support rod. This is normal.

Electric sensor boot lid

Open



E03AF5037DFC

- › When carrying the smart key, press the boot lid micro switch.
- › With the power supply in the OFF mode, press and hold the boot lid control button on the key.
- › When the driver's door is unlocked, press the boot lid micro switch.
- › When the driver's door is unlocked, press the boot lid control switch near the steering wheel.



414CE206216E

- › You can set boot lid sensor opening in **【Vehicle Settings】** → **【Body】** → **【Door Lock】** on the multimedia screen. Once enabled, when carrying the smart key, perform a kicking action in the detection area under the rear bumper.



58F5F2320A1A

Close

- › Press the close button on the boot lid.



6D9D1CF7CF6D

- › When the driver's door is unlocked, press the boot lid control switch near the steering wheel.
- › With the power supply in the OFF mode, press and hold the boot lid control button on the key.
- › Perform a kicking action in the detection area under the rear bumper.

i NOTICE

- › When performing the kicking action, position your foot close to the rear bumper and kick the tip of your foot at least 10 cm below the bumper. Do not touch the bumper. Then, quickly retract your foot. Otherwise, you may not be able to open or close the boot lid.
- › If you move your leg horizontally below the bumper, the boot lid may not open or close.
- › If the kicking action under the bumper takes too long or the kick is too slow, the boot lid will not open or close. If this occurs, repeat the kicking action faster.
- › If the boot lid does not open after several kicks, wait a few moments and try again.
- › If you are not carrying the smart key, performing a similar kicking action in the detection area under the rear bumper can also close the boot lid.

⚠ CAUTION

When using a car wash or using a high-pressure hose to wash the car, make sure that the smart key is not inside the detection range of the boot lid, so as to prevent the boot lid from being opened accidentally.

⚠ WARNING

- › When performing the kicking action,

be sure you keep your balance and stay a sufficient distance from the rear of the vehicle. Otherwise, you may lose your balance (for example: if on ice).

- › In the following situations, do not carry the smart key to prevent the boot lid from accidentally opening or closing.

When placing or picking up items behind the vehicle.

Polishing the vehicle rear and other maintenance work.

WARNING

- › In some situations, if manual closing of the boot lid is required, be sure to push down the boot lid from outside the vehicle to fully close it.

If you only use the hand grip to close the boot lid directly, it is easy to trap your hand, and this could cause an injury.

- › Driving the vehicle with the boot lid open is prohibited.
- › It is prohibited to carry passengers in the luggage area.
- › If there are other people in the vicinity of the boot lid, ensure that they are not hurt when opening or closing the boot.
- › When closing the boot lid, ensure that nothing you are carrying or wearing becomes trapped in the door.

- › Do not let children operate the boot lid. This could lead to an injury.

CAUTION

- › If manual opening or closing of the boot lid is required, please ensure that it is opened or closed slowly and steadily. Do not suddenly and forcefully open or close the boot lid.

- › Use caution when opening the boot lid in strong wind. When windy, the boot lid may open too far causing it to distort.

- › If the boot lid is frozen shut or covered with ice and snow, do not force open the boot lid. Use the A/C heating function to increase the temperature in the vehicle before opening the boot lid.

If the boot lid must be opened in an emergency, warm water may be poured on it to melt the ice. Wait until the ice has loosened before trying to open the boot lid.

- › Do not fix or stick anything onto the boot lid support rod.
- › Do not pull sideways on the boot lid, as this may result in the support bending.
- › In the process of opening or closing, do not force it in the opposite direction, as this may result in injury or damage to the boot lid.

i NOTICE

- › When the ambient temperature is lower than 0°C, the boot lid support may not automatically raise the boot lid. If this happens, the boot lid can be manually raised to open it.
- › Do not install heavy attachments on the boot lid, as this may cause the support to fail to hold the boot lid up.

Anti-trapping function

If the boot lid encounters an obstruction during the auto-close process, it will automatically return to the open position.

Opening angle settings

If you need to set the boot lid opening angle, use the following method:

1. Open the boot lid, adjust it to the desired height, and hold it.
2. Press and hold the close button on the boot lid until the vehicle lights flash. This indicates that the opening angle has been set successfully.

Emergency unlock

1. Using a flathead screwdriver, pry off the emergency cover located on the bottom section of the inner side of the boot lid.

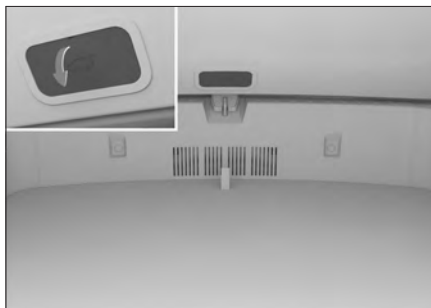

6902A399A857

i NOTICE

Please wrap the screwdriver head with cloth before disassembly.

2. The emergency release should be slid in the direction shown in the image using a flat head screwdriver. The boot lid will then open.

Boot lid - manual

1FA59C1D4C17

Electric sensor boot lid



F57ED31F5376

i NOTICE

In some situations, if you need to use the manual emergency release, take care to avoid contact with the surrounding metalwork to avoid scratching yourself.

Child lock

If a child is in the vehicle, it is advisable that they sit in a rear seat as this is safer. The rear doors have child locks fitted in order to prevent children from accidentally opening the doors.



DC3485600039

Pushing the lever in the direction shown by the arrow turns the child lock on.

Pushing it in the opposite direction turns the child lock off.

! WARNING

Only the rear doors have child locks. If the child is alone in the rear seats, please engage the child locks on both rear doors at the same time, to avoid accidents caused by the doors being opened unintentionally.

i NOTICE

When the child lock is engaged, you can only open the door by pulling the handle on the outside.

Parking unlocking

Go to **【Vehicle Settings】** → **【Body】** → **【Door Lock】** on the multimedia display to turn parking unlocking on or off. When this function is on and the vehicle is stationary and ON (the READY light on the instrument panel is illuminated), all doors are automatically unlocked when the driver-side seat belt is unbuckled or the car is switched to P.

Auto lock

You can turn off or set the auto lock speed in **【Vehicle Settings】** → **【Body】** → **【Door Lock】** on the multimedia screen.

i NOTICE

Before driving, confirm that all doors and the boot lid are fully closed.

Automatic relock

When all the doors and the boot lid are locked, once you have successfully unlocked the doors by touching the unlocking sensor on the door handle or pressing the unlock button on the key, if the state of none of the doors changes within 30 seconds, all doors will be automatically locked again.

Collision auto-unlock

When the vehicle is turned on, if the system detects a collision, all doors automatically unlock.

Vehicle equipment

Please note that this manual describes all standard equipment, country-specific equipment and special equipment for this series. Therefore, some equipment or functions described in this manual may not be installed in your vehicle or only available in certain markets. To learn more about specific configurations, please refer to sales documents or consult the dealer where you purchased the vehicle.

Window switch

Driver's window switch

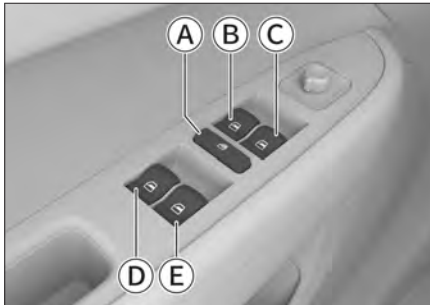

- Ⓐ Window lock switch
- Ⓑ Driver's window switch
- Ⓒ Front passenger window switch
- Ⓓ Left rear window switch
- Ⓔ Right rear window switch

Manual operation

Push the switch down to lower and pull the switch up to raise the window. The window will stop moving as soon as the switch is released.

⚠ WARNING

Make sure no passenger has any part of their body outside the window before closing it, or this could result in a very serious injury.

One-touch power windows

Pressing the window switch past the point of greatest resistance and then releasing it lowers the window all the way. If you want it to stop half-way, all you need do is pull up the switch.

Pulling the window switch past the point of greatest resistance and then releasing it raises the window all the way. Press down on the switch if you want to stop it half-way.

⚠ CAUTION

The windows and window frames may freeze in low temperatures preventing normal raising or lowering of the windows. Do not try to force them to move by trying to raise and lower them repeatedly, because this could damage the window motor. Normal operation will resume when the temperature in the vehicle rises and the windows unfreeze.

Window lock

After pressing the window lock switch, the window switches on the rear doors cannot be used to operate the windows. Press the vehicle window lock switch

again to allow the rear door switches to work again.

WARNING

If there are children in the vehicle, we recommend that they should be seated on the rear seats as this is safer, and the window lock function should be enabled.

Passenger side window switch

The armrest of each of the passenger doors has a window switch. By operating the switch, the corresponding window can be opened or closed.

Heat protection function

After repeated operation of a window switch, the heat protection function may be triggered to protect the window motor. At this time, the window switch will be temporarily disabled and it will not be possible to control or open and close the window. Once the motor has cooled down, the window switch will automatically return to normal.

Anti-trapping function

When the window closes automatically, if a foreign object is detected between the window frame and the window, the window will stop closing and open a certain distance automatically.

WARNING

› Do not test the anti-trapping function with any part of your body.

› If something gets stuck at the moment the window closes completely, the anti-trapping function will not be effective.

NOTICE

In severe conditions, such as low temperatures and with violent shaking, the anti-trapping function may be triggered when the window is closing, causing it to fail to close smoothly. At this time, please pull up the window switch past the point of greatest resistance to close the window.

Delay function

After switching the power supply from ON mode to OFF mode, you can still operate the window for 42 seconds.

If any door is opened within 42 seconds, the window delay function will turn off.

Easy close

When the vehicle power supply is in OFF mode, and all doors and the boot lid are closed, press and hold the lock button on the key or touch and hold the lock sensor on the door handle, and all windows will close automatically.

When the windows go up automatically, pressing the lock or unlock buttons on the key will stop them from going up.

NOTICE

When the windows go up automatically, if there is an obstruction between

the window and the window frame, the anti-trapping function may be triggered. Please confirm that the window is completely closed before leaving.

Initialisation

When the one-touch opening and closing function malfunctions, it can be reset with the following operation:

1. Switch the power supply to the ON mode.
2. Raise the one-touch operation window switch beyond the point of greatest resistance, until the window closes completely, and hold for about 3 seconds.
3. Operate the window switch again so that the window completes one-touch opening and one-touch closing once.

NOTICE

When the one-touch opening and closing function malfunctions, a window with one-touch functionality need to be initialised. It will also need to be initialised each time the battery is disconnected and reconnected.

Vehicle equipment

Please note that this manual describes all standard equipment, country-specific equipment and special equipment for this series. Therefore, some equipment or functions described in this manual may not be installed in your vehicle or only available in certain markets. To learn more about specific configurations, please refer to sales documents or consult the dealer where you purchased the vehicle.

Sunroof operation



566387D857AC

Manual operation

- › Press upwards and hold the sunroof button, once the tilt angle of the sunroof reaches the maximum it will stop; press and hold the button again and the sunroof opens gradually.
- › Press the sunroof button downwards, and the sunroof gradually closes.
- › If you want to stop the sunroof midway, release the button.

Automatic operation

- › Press the sunroof button upwards and

release, and the sunroof automatically stops when the angle of tilt reaches the maximum; then press the sunroof button again and release it, and the sunroof automatically opens to a suitable position; then press the button again and release it, and the sunroof automatically opens fully.

- › Press the sunroof button downwards and release, and the sunroof automatically closes.
- › If you want to stop the sunroof midway, press the button again.

⚠ WARNING

- › Do not stick your hand or head out of the sunroof while the vehicle is moving. If you collide with something or you brake suddenly, it is likely to cause serious injury to the occupant or even death.
- › When closing the sunroof, ensure that nobody's hands, head or neck etc. get trapped, otherwise a serious injury could occur.
- › Do not let children operate the sunroof.

Closing and opening the sunshade



7411604390DE

Manual operation

- › Press the sunshade button upwards and hold, and the sunshade will gradually open.
- › Press the sunshade button downwards and hold, and the sunshade gradually closes.
- › Release the button to stop the sunshade mid way.

Automatic operation

- › Press the sunshade button upwards and then release it, and the sunshade will open automatically.
- › Press the sunshade button downwards and then release it, and the sunshade will close automatically.
- › If you want to stop the sunshade mid way, press the button again.

⚠ WARNING

- › When closing the sunshade, ensure that nobody's hands, head or neck get trapped, as this could result in

serious injury.

- › Don't let children operate the sunshade.

⚠ CAUTION

Do not exert force on the sunroof sunshade, as this could cause it to fall out or damage it.

If the vehicle is parked for a long time, it is recommended that the sunroof sunshade should be kept closed to prevent damage to the interior trim from high temperatures in the vehicle due to prolonged exposure to the sun.

Linked function

When the sunshade is in the closed position, as the sunroof opens, the system will automatically adjust the extent to which the sunshade opens to the same extent as that of the sunroof.

Anti-trapping function

If the sunroof or sunshade encounters an obstruction during the course of automatic closing, the sunroof or sunshade may stop and reverse for a distance.

⚠ WARNING

You should not attempt to test the anti-trapping function using any part of your body.

If something gets trapped at the moment the sunroof and sunshade close completely, the anti-trapping function

will be ineffective.

Delay function

The power supply and the sunshade can still be operated for a few seconds after switching the sunroof power supply from the ON mode to the OFF mode.

Easy close

When the power supply is in OFF mode and all the doors and the boot lid are closed, press and hold the LOCK button on the key or the LOCK sensor on the door handle, and the sunroof will close automatically.

Automatic closing function

- › When the power supply is in the OFF mode if the optical rain sensor detects rain or snow, the sunroof will automatically close.

i NOTICE

If the rain is very light, the sunroof may not automatically close, and you must check to see if the sunroof is completely closed before leaving the vehicle.

- › While the vehicle is being driven, the sunroof will close automatically when the vehicle speed exceeds 120 km/h.

Initialisation

When an error occurs in the system, it can be reset in the following manner:

1. Close the sunroof and sunshade completely, then press and hold the

sunroof button down until the sunroof and sunshade both click into place.

2. Within 5 seconds, press and hold the sunroof button down again until the sunroof and the sunshade have opened and then fully closed again. Initialisation is complete.

If the sunroof reverses when closing, you can force it to initialise as follows:

1. When the sunroof reverses, immediately press and hold the sunroof button down, and after it stops reversing, continue to hold the sunroof button down until the sunroof is fully closed and clicks into place.
2. Within 5 seconds, press and hold the sunroof button down again until the sunroof has opened and then fully closed again. Initialisation of the sunroof is complete.

If the sunshade reverses during closing, you can force it to initialise as follows:

1. First, completely close the sunroof.
2. Close the sunshade again and once it begins to reverse, immediately press and hold sunshade button down. After it stops reversing, continue to hold the sunshade button down until the sunshade is fully closed and clicks into place.
3. Within 5 seconds, press and hold the sunshade button down again until the sunshade has opened and then

fully closed again. Initialisation of the sunshade is complete.

Bonnet

Vehicle equipment

Please note that this manual describes all standard equipment, country-specific equipment and special equipment for this series. Therefore, some equipment or functions described in this manual may not be installed in your vehicle or only available in certain markets. To learn more about specific configurations, please refer to sales documents or consult the dealer where you purchased the vehicle.

Opening

1. Pull the bonnet release knob located below the dashboard, and the bonnet will rise slightly.

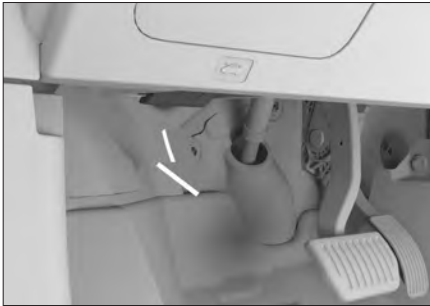

2. Open the bonnet by lifting it slightly, and putting your hand into the gap. Move the bonnet catch in the direction of the arrow.



3. Unhook the support rod and insert the front-end into the slot in the bonnet to hold it open.

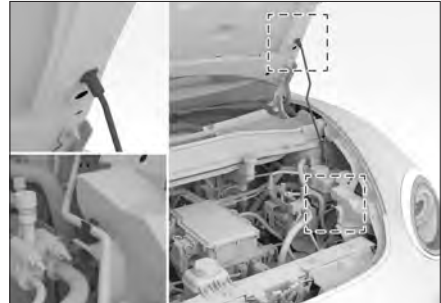

Closing

1. Lift the bonnet slightly.
2. Unhook the support rod, and return it to its original position.
3. Release the bonnet from a height of about 30 cm and allow it to fall freely.
4. Confirm the bonnet is fully locked.

WARNING

Make sure the bonnet is closed and

firmly locked before driving off, otherwise, it might open unexpectedly while driving, and could result in an accident.

 **CAUTION**

Before closing the bonnet, please check for any items left in the engine compartment.

Vehicle charging

Vehicle equipment

Please note that this manual describes all standard equipment, country-specific equipment and special equipment for this series. Therefore, some equipment or functions described in this manual may not be installed in your vehicle or only available in certain markets. To learn more about specific configurations, please refer to sales documents or consult the dealer where you purchased the vehicle.

Charging mode

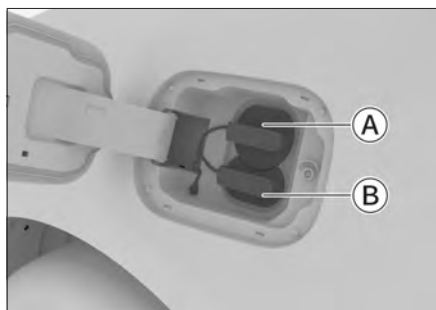

- › (A): Standard charging port (AC charging)
- › (A+B): Fast charging port (DC charging)

The time required for charging varies depending on the battery charging status, usage time, temperature, and status of the power supply connected. Charging time is shortest at room temperature.

⚠ WARNING

- › If you have medical implant such as a defibrillator, verify with the

manufacturer of the device whether its operation may be affected before charging.

- › There should be no-one inside the vehicle while it is being charged. Persons with medical implants such as a defibrillator that could be affected may not enter the vehicle or luggage area to take things out.
- › Before charging, make sure that the vehicle, socket, power supply device, and terminal of the charging cable are free from water or other foreign matter, also check that the metallic contacts are not rusted or corroded, otherwise do not charge. Faulty contacts can lead to short-circuit or electric shock, with a risk of injury.
- › Ensure the charging device is kept out of the reach of children. Children and others requiring supervision should not charge the vehicle.
- › In rain or snow, do not charge the vehicle outside. When charging is complete, ensure that there is no water on your hands or the charging port before removing the charging device to avoid the risk of shock.

⚠ CAUTION

- › The use of generators with an unstable voltage for charging is prohibited. Otherwise, damage to the vehicle may occur.
- › It is recommended the vehicle is

placed in Park/Neutral and is stationary before charging.

- › During the charging process, if any odours or smoke are detected, you must immediately stop charging, move people out of the area, and keep at a distance from the electric vehicle; contact a service provider for inspection.
- › During the charging process, the cooling fans within the engine compartment may suddenly start to operate. Take care to avoid touching fans with your hands, feet, clothing or jewellery etc.
- › During charging, disconnect high power electrical devices to maintain charging efficiency.
- › It is recommend that charging is conducted using a stable power network, and at designated charging facilities. The following conditions may prevent vehicles from charging normally:

Large power network fluctuations, and amplitudes or frequencies beyond national standard values.

If charging facilities in public places lack effective supervision and maintenance, and the charging plug is damaged or contains foreign matter. Some charging piles are provided as public infrastructure without undergoing suitability verification; the charging plugs of certain

manufacturers do not fit the vehicle sockets properly.

- › For charging piles that require swipe cards or code scanning, complete card swiping or code scanning within 5 minutes of connecting the charging gun, otherwise re-insert the charging gun and repeat the operation.

Charging cable

The charging cable is located within the luggage area.

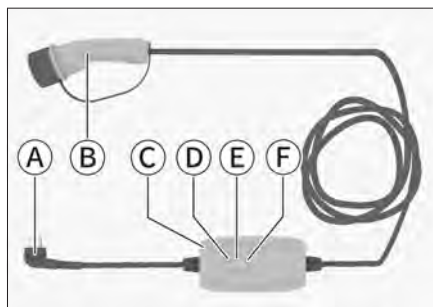

60F1C04C7948

- Ⓐ Plug
- Ⓑ Charging gun
- Ⓒ Control unit
- Ⓓ Power supply light
- Ⓔ Fault light
- Ⓕ Charging light

i NOTICE

- › The charging cable may have different plugs due to voltage and target market differences. This image is for reference purposes only.
- › The charging cable that comes with the vehicle can only be used for

normal charging.

- › For easy reference, the reverse of the charging power cable control unit is printed with a description of what the lights mean and usage precautions.

⚠ CAUTION

- › Before charging, make sure that the plug on the charging cable is fully plugged into the socket. Otherwise there is a risk of shock or arcing in the charging circuit.
- › Do not carry out charging with a damaged charging cable.
- › We recommend using an original manufacturer's charging cable. If you use other cables, the power battery may not charge properly and a fault may occur.
- › Do not disassemble, repair or alter charging equipment (charging power cables, charging terminals, etc.), otherwise charging faults and fires could occur.
- › When starting the vehicle, make sure that the charging gun has been fully withdrawn, otherwise damage to the charging equipment and vehicle may result.
- › To prevent the charging cable from breaking, note the following:
Do not forcibly stretch, distort, bend, or step on power cable components.
Charging cables should not be placed

near heaters or other high temperature objects

Do not store or use charging cables in locations hotter than 85°C.

Avoid using in direct sunlight or damp locations.

Normal charging

1. Switch the power supply mode to OFF.

⚠ CAUTION

We recommend switching the power supply mode to OFF when charging. Charging is not recommended when in the ON mode.

2. Press on one side of the charger port cover and it will gently spring open.



A4850A167008

3. Take out the charging power cable and insert the plug into the socket.

⚠ WARNING

- › The power supply side must have a circuit breaker installed. You must use a socket of the corresponding specification which matches the

charging cable supplied with the vehicle.

- › In the charging circuit, avoid using excessive extensions and adapters, and avoid using an excessively long cable. This is to prevent the risk of excess heat or arcing resulting in a risk of fire or electric shock.
4. Remove the dust cover from the normal charging port and the protective cover from the head of the charging gun. Insert the charging gun into the normal charging port.

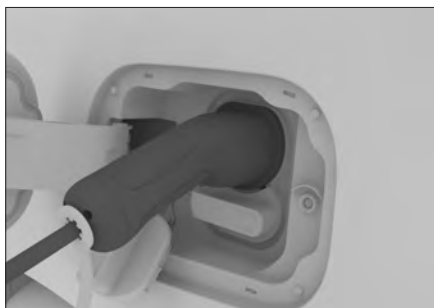

BE6A4C377FEC

When the power supply is turned on, the charging gun will automatically lock. At this time, the connection light on the control unit and the charging connection light on the instruments panel will light up.

⚠ CAUTION

If a charging gun or charging port has a foreign object in it which prevents connection, do not force it in. Contact an authorised service provider immediately. Forcing it in can damage the

charging installation and vehicle.

If the charging port is frozen, you can use a hairdryer to thaw it out. If a charging gun is forced in when the port is frozen, it will cause a fault.

i NOTICE

You can set the charging mode on the multimedia screen by pressing **【Power Assistant】** → **【Charging Management】** .(> Page 172)

When set to immediate charging, charging begins upon connection to the power supply.

5. When charging, the charging indicator light on the instruments panel  will come on. At the same time, the power supply light and connection light on the control unit will remain on, and the charging light will flash. When the charging light of the control unit is constantly on, this indicates that charging is complete. You can set a power battery charging percentage in **【Power Assistant】** → **【Charging Management】** on the multimedia screen. When the battery charge reaches the level set, it will automatically stop charging. If normal charging is not possible, refer to the light status descriptions on the charging power cable control unit. If there is a fault, contact an authorised service provider as soon as

possible.

6. When charging is complete, unlock the driver's door and remove the charging gun.

i NOTICE

If the charging gun cannot be removed, use one of the following methods to release the charging gun.

- › Lock the doors once and then unlock them again.
- › Release using the emergency release method.

7. Then remove the plug from the power supply.

i NOTICE

After completion of normal charging, if the charging gun is left inserted and the conditions for charger warming or cooling are met, it will keep the temperature of the battery within the optimal temperature range for 6 hours.

You can turn the charging gun warming/cooling feature on or off in **【Power Assistant】** → **【Charging Management】** on the multimedia screen.

(▷ Page 94)

8. Replace the protective cover of the charging gun and the normal charging port dust cap, close the charging port cover, and return the charging power cable to its original position.

! CAUTION

- › The first time you use the vehicle or when using it after it has been parked for a long time, there may be a deviation in the charge shown on the instrument panel display. We recommend that you fully charge the vehicle before use.
- › Regular charging makes the battery work best. Don't wait until the battery is low before charging. Recharge every other week to ensure the battery charge estimate is accurate.
- › When the vehicle exits REDAY mode due to low power battery, the vehicle may not be charged after the charging gun is inserted. In this case, you need to switch the power mode to ON, then to OFF, and then start to charge. If it still can not be charged, please contact the authorised service centre.

Emergency release

1. If release does not occur in normal charging mode, open the bonnet and find the emergency cable release at the back of the standard charging port. Pull the emergency cable release in the direction shown by the arrow.



A3D61BAF3710

2. Then pull out the charging gun.

Fast charging

Before fast charging, carefully read the operating instructions on the charging device and observe the rules of the charging station strictly.

1. Switch the power supply mode to OFF.

⚠ CAUTION

It is recommended the power supply mode be switched to OFF when charging. Charging is not recommended when in the ON mode.

2. Press on one side of the charger port cover and it will gently spring open.



A4850A167008

3. Remove the fast charging port dust cap and follow the operating instructions on the charging device exactly.
4. When the power supply is turned on, the charging gun will become automatically locked in place. The charging indicator light on the instruments panel  will light up.

⚠ CAUTION

- › Frequent fast charging will affect the life of the battery. Normal charging is recommended.
- › When charging using a fast charging port, ensure that the charging gun is connected properly, otherwise, the lithium battery will not charge, or the charging equipment will be damaged.

5. After charging is complete, replace the charging port dust cap and close the charging port cover.

Vehicle equipment

Please note that this manual describes all standard equipment, country-specific equipment and special equipment for this series. Therefore, some equipment or functions described in this manual may not be installed in your vehicle or only available in certain markets. To learn more about specific configurations, please refer to sales documents or consult the dealer where you purchased the vehicle.

Headrests

Headrest adjustment

Only when the centre of the headrest is adjusted to the height of the upper part of the ear will it provide the greatest protection.

WARNING

The headrest must not be adjusted while the vehicle is being driven.



54725A41130F

- › If you wish to raise the headrest, you just lift it directly to the required position.

- › To lower the headrest, press the headrest adjustment button and push the headrest down to the desired position.

NOTICE

The lowest position of the headrest is not for usage. Be sure to adjust the headrest up to a locked position for usage.

Adjust the headrest and press down on it to make sure it is securely locked.

Headrest disassembly

To remove the headrest, push the headrest adjustment button in and pull out the headrest completely.

If necessary, adjust the seat back so that you can disassemble the headrest.

WARNING

The headrest must not be removed while the vehicle is being driven. If this is done and a collision occurs, the neck of the driver or passenger neck will be subject to major strain, potentially resulting in serious injury or even death.

Front row manual seats

WARNING

- › The seats must not be adjusted while the vehicle is being driven.
- › Please adjust your seat to a position that will facilitate correct driving before driving off. Otherwise erroneous operation could lead to an accident;

the protective safety functions of the seat belt, airbag or headrest could also become ineffective.

- › Do not tilt the seat back too far to avoid sliding out under the waist belt. The seat belt provides maximum protection only when you sit up straight and lean back properly against the seat back.

Forwards and backwards adjustment of seats



5A3DD2E15ACA

Pull up the seat position adjustment bar, slide the seat forwards or backwards to the desired position, and release the adjustment bar.

i NOTICE

After adjusting the seat, make sure that it is firmly locked in place.

Seat back angle adjustment



0EA387B5AF98

Leaning back against the seat back, pull up the seat back angle adjustment handle; lying back against the seat back will allow you to adjust it to the desired angle, then release the adjustment handle.

! CAUTION

Raise the seat back angle adjustment handle fully before adjusting the seat back. Otherwise a mechanical seat fault may result.

Seat height adjustment



2FF3C1AEC46D

- › To raise the seat, repeatedly pull the seat height adjustment handle upwards.
- › To lower the seat, repeatedly push the

seat height adjustment handle downwards.

i NOTICE

Some functions apply only to the driver's seat.

Ⓑ Seat height adjustment

Ⓒ Forwards and backwards adjustment of seats

i NOTICE

Some functions apply only to the driver's seat.

Front row electric seats

⚠ WARNING

- › The seats must not be adjusted while the vehicle is being driven.
- › Please adjust your seat to a position that will facilitate correct driving before driving off. Otherwise erroneous operation could lead to an accident; the protective safety functions of the seat belt, airbag or headrest could also become ineffective.
- › Do not tilt the seat back too far to avoid sliding out under the waist belt. The seat belt provides maximum protection only when you sit up straight and lean back properly against the seat back.

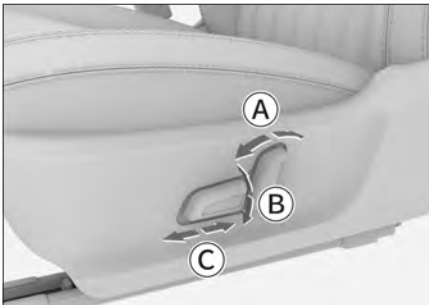

C3E6312A0671

Ⓐ Seat back angle adjustment

Rear row seat adjustment

Folding down the seat backs

The rear row seat backrests can be folded to obtain additional storage space. It is possible to fold down the left or right side seat back separately.

i NOTICE

- › Prior to folding down, adjust the headrests to a suitable position to avoid interference with the seat cushions or the front seats.
- › Return the seat belts to their original positions to prevent them interfering when folding down the seat backs.



3CEFOA4D5CB

Pull up the seat back release strap, and the unlocked seat back can be folded forward.

⚠ CAUTION

- › Before a seat back is folded down, all items should be taken off the seats.
- › When a seat back is folded down, do not place any heavy items on it.

⚠ WARNING

- › Seat backs must not be adjusted or folded while driving.
- › You should not sit on a folded seat back or in the luggage area.
- › Children should not enter the luggage area.

Seat back return

1. Adjust the seat belts so that they do not get stuck under the seat when the seat back is returned to its upright position.
2. Pull up the seat back to return it to its upright position. Wiggle the seat back and forth to ensure that it is locked in place.

Easy entry function

With the power supply in ON mode, you can reach the seat memory settings menu from **【Vehicle Settings】** → **【In-Car】** → **【Driver Seat】** on the multimedia screen.

After the easy entry function is turned on:

- › When the driver unclips their seat belt and opens the driver-side door, the driver's seat will automatically retract

a certain distance so that the driver can exit the vehicle.

- › When the driver returns, is seated, and the driver's side door is closed, the driver's seat will return to the position that it was in before it retracted.

i NOTICE

- › If the seat adjuster switch is operated in the process of the driver's seat automatically retracting or returning to the original position, the seat will carry out the command input by the adjuster switch.
- › If the seat is adjusted in any way after the driver's seat is automatically retracted, the seat greeting function will not be capable of returning it to its original position.

Driver's seat memory

With the power supply in ON mode, you can reach the seat memory settings menu from **【Vehicle Settings】** → **【In-Car】** → **【Driver Seat】** on the multimedia screen.

Touch the arrow buttons surrounding the seat image, and you can adjust it accordingly.

When set to **【Manual Memory】** the position of the driver's seat can be manually saved to the memory button. By holding down the memory button, the present position of the driver's seat can be saved, and at the same time there is

an alert that the seat position has been successfully saved. By touching the memory button, you can call up a driver's seat position that has been saved with the button.

1 When set to **【Automatic Memory】** the driver's seat position will be automatically saved to the personal account of the person logged in. After logging in to a personal account, the driver's seat will adjust automatically to the position last used.

Seat settings

Touch the ❁ button on the left side of the display screen to access the seat setting screen (it shares the same screen as the air-conditioning settings).



0D76872086CD

Seat heating/ventilation

By touching the seat icon at the bottom of the A/C settings, the heating (or ventilation) functions corresponding to the seat can be set in the pop-up menu.

⚠ WARNING

When the seat heating function is used, care should be taken with the following types of passenger:

- › Infants, children, the elderly, the sick or the disabled.
- › Persons with sensitive skin.
- › Persons that are overly tired.
- › Persons under the influence of drink or drugs.

⚠ CAUTION

- › The seat and its power or ventilation systems must not be customised in any manner. If this is done it may affect the function or useful life of the seat heating.
- › To avoid the seat overheating, do not place blankets, mats or other insulation on the seat when the seat heating function is being used.
- › In order to avoid draining the battery, do not use the seat heating function for long periods of time without starting the car.
- › When the following circumstances arise, the seat heating may be damaged and should be inspected before being used:

If a large amount of water has been spilt on the seat;
If the seat is ripped by a sharp object (such as a badge pin or a knife, etc.);
If the seat emits a strange odour.

Seat massage

Touch the **【Seat】** button on the A/C settings interface to enter the seat massage function interface.

- › Touch the **【Massage Adjustment】** button to switch the seat massage function on or off for the corresponding seat.
Touch **【Light】** or **【Strong】** to set the strength of the massage.

Vehicle equipment

Please note that this manual describes all standard equipment, country-specific equipment and special equipment for this series. Therefore, some equipment or functions described in this manual may not be installed in your vehicle or only available in certain markets. To learn more about specific configurations, please refer to sales documents or consult the dealer where you purchased the vehicle.

Rear view mirror

Manual anti-glare

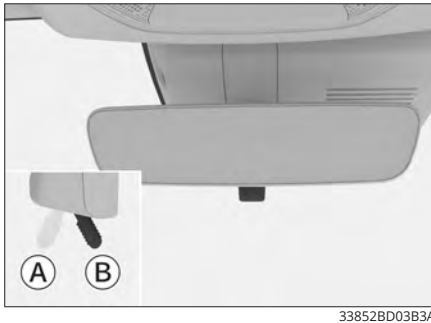

- Ⓐ Normal position
- Ⓑ Anti-glare position

You can switch to anti-glare position by tugging the handle towards the back of the vehicle. This position can reduce the glare of the headlamps of vehicles behind you.

Automatic anti-glare



The rear view mirror automatically reduces glare according to the intensity of the headlamps of vehicles behind you.

Side mirror adjustment



- Ⓐ Initial position
- Ⓑ Select the right side mirror
- Ⓒ Select the left side mirror
- Ⓓ Side mirror folding

Mirror surface adjustment

1. Turn the side mirror adjustment knob to select the right side or left side mirrors.
2. Move the knob to the front, back, left or right to adjust the mirror surface of the left or right side mirror.

3. After adjustment is completed return the side mirror adjustment knob to its initial position.

⚠ WARNING

Do not adjust the rear view mirror while driving. Doing so may result in your losing control, and could result in an accident or serious injury.

Electrical folding

Turn the adjustment knob to  the external rear view mirror folding position, and the external rear view mirrors will fold automatically.

Turn the adjustment knob to another position, and the external outside rear view mirrors will automatically fold out.

Manual folding



C0991A2D9776

Pull the outside of the side mirrors in the direction of the arrow and they will fold in.

Before driving, you must return the side mirrors to the usage position.

⚠ CAUTION

Do not fold automatic side mirrors manually. Doing so may damage the internal structure of the rear view mirror.

Side mirror settings

You can set the side mirror functions in **【Vehicle Settings】** → **【Body】** → **【Side Mirrors】** on the multimedia screen.

- › **【Fold Side Mirrors】** : Set the side mirror folding mode.

When set to automatic folding mode, the side mirrors are automatically folded/unfolded when the doors are locked/unlocked.

- › **【Reverse Auto-Tilt】** : Turn reserve auto-tilt on or off.

When reverse auto-tilt is turned on, the side mirrors automatically adjust to a saved position that is suitable for reversing when you place the vehicle in Reverse. When you exit Reverse, the side mirrors automatically return to their position before the vehicle was put in Reverse.

To save the side mirror auto-tilt position, turn on reverse auto-tilt, change into Reverse, adjust the angle of the side mirrors to the angle to be used to ensure a better field of vision when reversing, and then exit Reverse.

Side mirror defrosting function

When the side mirror surface has frost on it or is fogged up, if the rear defrost button on the A/C information screen is pressed, the indicator lights up, and the side mirror defrosting function turns on. Press the rear defrost button again to turn off the defrosting function.

The side mirror defrosting function turns off automatically after a period of time.

WARNING

After the side mirror defrosting function turns on, do not touch the mirror surface as it will be hot and can cause a burn.

Steering wheel

Vehicle equipment

Please note that this manual describes all standard equipment, country-specific equipment and special equipment for this series. Therefore, some equipment or functions described in this manual may not be installed in your vehicle or only available in certain markets. To learn more about specific configurations, please refer to sales documents or consult the dealer where you purchased the vehicle.

Adjustment method



9ACBC991D4DB

1. Release the adjustment lever under the steering wheel.
2. Adjust the steering wheel so that it points at the front of your chest, and make sure you can see all the instruments and lights on the instruments panel.
3. When adjustment is complete, push the adjustment lever back in to lock the steering wheel.

WARNING

- › Do not adjust the steering wheel

while the vehicle is moving. Otherwise, incorrect operation could result in an accident or serious injury.

- › After adjusting the steering wheel, ensure that it is securely locked in place. Otherwise, sudden movement of the steering wheel could result in an accident or serious injury.

Horn

Press on or around the horn symbol on the steering wheel to sound the horn.

Heating function

Touch the  screen to enter steering wheel heating settings menu (shares the same menu with the air-conditioning settings).



Touch the steering wheel area on the screen to turn the steering wheel heating function on or off. When the steering wheel heating function is turned on, the steering wheel symbol turns red.

CAUTION

If the vehicle is not running, do not keep the steering wheel heating function on for a long period of time to avoid draining the battery.

Lighting controls

Vehicle equipment

Please note that this manual describes all standard equipment, country-specific equipment and special equipment for this series. Therefore, some equipment or functions described in this manual may not be installed in your vehicle or only available in certain markets. To learn more about specific configurations, please refer to sales documents or consult the dealer where you purchased the vehicle.

Lighting control combination switch

Master light switch

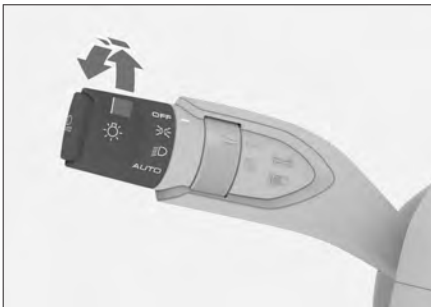

70260F8707B3

- › Twist the master light switch to  the side lights position, to turn on the sidelights and number plate light.

CAUTION

When driving do not use sidelights instead of dipped headlights. Otherwise, there is the risk of an accident.

Because the sidelights are not bright enough to illuminate the road in front of the vehicle or to allow other vehicles

and pedestrians to see the vehicle, with dark skies or poor visibility, turn on the low-beam.

- › Twist the master light switch to  the low-beam position to turn on the low-beam, the sidelights and number plate light remain on.
- › Twist the master light switch to the AUTO position and the sidelights and low-beam will automatically turn on or off according to the brightness of the ambient light.

CAUTION

- › The lights may not automatically turn on during the day when the field of view is affected by heavy fog. Turn on the lights manually.
- › Automatic lighting controls are only an aid to driving. At all times, the driver is responsible for the vehicle lights.
- › Twist the master light switch to the OFF position to turn off all lights.

Fog lamp switch



726C157B93A5

When low-beam is on, twisting the fog lamp switch to 0 the rear fog lamp position turns the rear fog lamp on or off. When you release the knob it will go back to its original position.

Steering and lane changing signals

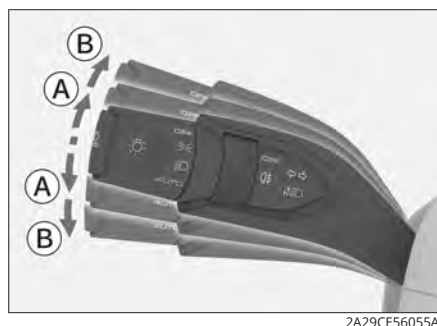

2A29CE56055A

- Ⓐ Lane changing signals
- Ⓑ Steering signals
- › Lane changing signals: Move the lighting control combination switch lightly up or down and release it and the combination switch will return to its original position and the corresponding indicator will flash three times.
- › Turning signal: Move the lighting control combination switch up or down, after releasing it the combination switch will return to its position and the corresponding indicator will continue to flash.

High-beam/low-beam manual switching



48EE19FE236F

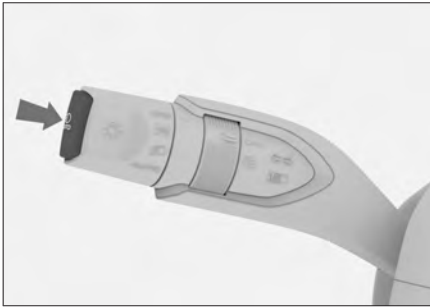

- Ⓐ High-beam on
- Ⓑ High-beam flashing
- › When low-beam is on, pushing the lighting control combination switch away from the steering wheel will turn the high-beam on or off. When you release it the combination switch will return to its original position automatically.
- › Pull the lighting control combination switch towards the steering wheel and the high-beam will turn on. When you release it, the combination switch will return to its original position automatically, and high-beam will turn off. Repeat this to flash your headlamps.

High-beam/low-beam automatic switching



34D6DB150609

The automatic main beam/dipped headlights switching function can automatically switch the lights according to the current vehicle speed and the brightness of the surrounding environment.

When low-beam is on and high-beam is off press  the high-beam/low-beam automatic switching button to turn the high-beam/low-beam automatic switching function on or off. After the function is switched on  the high-beam/low-beam automatic switching light on the instruments cluster lights up green.

WARNING

The high-beam/low-beam automatic switching function is only an aid. When traffic conditions or weather conditions require, drivers should manually switch to high-beam or low-beam according to brightness and visibility. Manual intervention is required in the following circumstance:

- › Weather conditions unsuitable for driving, such as heavy fog, rain and

snow, etc.

- › When driving round sharp bends or steep slopes.
- › When at a junction you cannot fully see oncoming vehicles, such as when the lights of oncoming vehicles are obscured by a crash barrier or when driving on a motorway.
- › When driving in conditions of poor light and in built-up areas.
- › When there are other poorly lit road users nearby, such as pedestrians or non-motorized vehicles.
- › When there are highly reflective objects near the road, such as traffic signs.
- › When the optical rain sensor on the windscreen is dirty, covered by ice or obscured in some other manner.

Hazard warning lights



52D894049C07

If the vehicle has broken down or is involved in a traffic accident etc., turn on the hazard warning lights to warn other drivers.

Press the switch to switch the hazard

warning lights on or off.

Daytime running lights

To make your vehicle more visible to other drivers, after starting the vehicle the daytime running lights switch on automatically.

When triggered, the daytime running lights are turned off under the following conditions:

- › When the headlamps are on.
- › When the left or right indicators are on, the daytime running lights on the same side will be off.

WARNING

Daytime running lights are not designed for night driving.

Follow me home headlights

The sidelights and low-beam will automatically light up for a period of time when the following conditions are met to ensure that you are able to leave the vehicle in the dark:

The power supply is in OFF mode, the master light switch is on AUTO or  in the low-beam position, the ambient light level reaches the level where the low-beam would come on, and all the doors and the boot lid are locked from outside the vehicle.

Emergency braking warning

If you emergency brake when the vehicle is travelling at more than 50 km/h,

the indicators will flash.

Levelling the headlamps



8F120C60FDB8

The height of the headlamp beams can be adjusted to take account of the number of passengers and the load in the vehicle.

- › Rotate knob upwards: raises the height of the headlamp beams.
- › Rotate knob downwards: lowers the height of the headlamp beams.

CAUTION

When driving into an area with different traffic directions, please contact the authorised service centre to adjust the headlights to avoid blinding drivers of oncoming vehicles.

Lighting settings

You can set lighting functions in **【Vehicle Settings】** → **【Lighting】** on the multimedia screen.

- › **【Find Vehicle Lighting】** : Turn the “Find vehicle lighting” function on or off.

When “Find vehicle lighting” is turned

on, the power supply is in OFF mode and the master light switch is in AUTO, then, if the current light level reaches that where low-beam would come on, the sidelights and low-beam will automatically light up for a period of time after the door is unlocked from outside the vehicle (other than with the mechanical key) to ensure you can approach the vehicle in the dark.

- › **【Power Saving Delay】** : You can set the power-saving function activation time.

After the power supply mode is switched to OFF, if the vehicle power supply and the door lock state do not change within the set time range, the power-saving function will start automatically.

- › Touch **【Dome Light Delay】** button to set the time delay for turning off the interior lighting after all the doors are closed if the door control function has turned on the interior lights and the power mode is set to OFF.
- › Touch **【Follow Me Home Headlights】** button to set the length of time the sidelights and low-beam stay on after the “Follow me home headlights” function is triggered.
- › **【Parked Car Alert Mode】** Sets the vehicle notification status when the ‘car search’ function is triggered.
- › **【Sport Mode Lighting】** Sets the lighting status when the driving mode is set to sport mode.

Interior lights



Reading lamp

⚠ CAUTION

Please do not use the interior lights for long periods of time without starting the vehicle, otherwise you might drain the battery.



E94DF4367B27

- › Pressing the  reading light switch will switch the reading lamp on or off.
- › Pressing the  door switch will switch the door control function on or off.

When the door control function is switched on, the reading lamp will automatically switch on or off when the door opens or closes.

Boot light

When the boot lid is opened or closed the boot light automatically switches on or off.

Vehicle equipment

Please note that this manual describes all standard equipment, country-specific equipment and special equipment for this series. Therefore, some equipment or functions described in this manual may not be installed in your vehicle or only available in certain markets. To learn more about specific configurations, please refer to sales documents or consult the dealer where you purchased the vehicle.

Front wipers

Front wipers lever positions



35F31A000F99

- Ⓐ Using the front wipers jog function (MIST)
Push the wiper control combination switch upwards to the MIST position. After releasing, it will automatically return to its position, and the front wipers will wipe once.
- Ⓑ Front wipers (OFF)
- Ⓒ Automatic (AUTO)
- Ⓓ Slow wipe (LO)
- Ⓔ Fast wipe (HI)

⚠ CAUTION

- › If the windscreen is very dirty or has material stuck to it (such as snow or tree sap), clean this off before using the wipers to avoid damaging the wiper blades or the internal components.
- › Before using the wipers in cold weather, check whether they are frozen to the windscreen. If the wiper blades are frozen to the windscreen, make sure to thaw them out before using them to avoid damaging the blades or the wiper motors.
- › If the wipers get stuck for some reason, for instance due to snow, turn them off and pull over to a safe location as soon as possible. Clear whatever is keeping the wiper from operating so that they can function normally.
- › Do not use the front wipers when the bonnet is open. This can damage the front wipers or the bonnet.
- › Do not use products that produce a coating on the windscreen (e.g. crystallised or coated washing liquid, glass coatings, etc.). Otherwise, this may cause the wiper to bounce and rattle when wiping.
- › Do not allow the wiper blades to come into contact with oil-based cleaning products, as this may cause a chemical reaction and lead to severe deformation of the wiper

blades.

Automatic wipe interval adjustment



20A90096558F

Rotating the adjustment knob changes the optical rain sensor's sensitivity to rain, thereby changing the wiping interval of the front wipers when set to automatic.

Washing



DE17145CA295

Pull the wiper control combination switch in the direction of the steering wheel and hold it there, and the front wipers will clean the windscreen with screen wash. After releasing, the combination switch returns automatically to its place.

⚠ CAUTION

- › Avoid using the washing function for extended periods, as this could damage the screen wash motor. The screen wash motor may shut-down automatically after being used for a period of time.
- › Regularly check the screen wash level in the fluid tank and refill as needed. Use screen wash that will not freeze in cold weather. Otherwise, not only will the washing function not work, but system components may be damaged by freezing.

Optical rain sensor



F81EF4A48EA2

The optical rain sensor is located in the vehicle at the top of the windscreen in a central position, close to the interior rear view mirror.

⚠ WARNING

- › The optical rain sensor may not identify rain and activate the front wipers under certain circumstances. If rain on the windscreen affects your view,

adjust the front wiper lever or wiper frequency manually when necessary.

- › When the automatic front wipers are set to AUTO, the front wipers may operate unexpectedly if the windscreen is knocked in the vicinity of the rear view mirror, or if the windscreen is subjected to vibration. Take care not to let the front wipers crush your fingers etc.
- › When washing the vehicle or if you do not require the front wipers, do not leave the front wipers in the AUTO position, otherwise, the front wipers may operate unexpectedly.

CAUTION

- › If the surface of the windscreen near the interior rear view mirror is dirty or obscured (with snow or stickers, etc.), it needs to be cleaned, otherwise the normal operation of the automatic wipers may be affected.
- › Because snowflakes have different shapes, even if snowflakes hit the optical rain sensor, the sensor may not react and the front wipers may not activate. When the snowflakes melt, this may cause the front wipers to operate automatically.

Windscreen washer nozzle heating function

For vehicles equipped with windscreen washer nozzle heating, this function is

turned on or off with the A/C system rear defrost setting. When this function is enabled, the front windscreen washer nozzles are slowly defrosted.

CAUTION

Do not leave this function on for a long time if the vehicle is not turned on because this will drain the battery.

Front wiper interval

You can set the front wiper interval in **【Vehicle Settings】** → **【Body】** → **【Front Wiper】** on the multimedia screen.

A/C system

Vehicle equipment

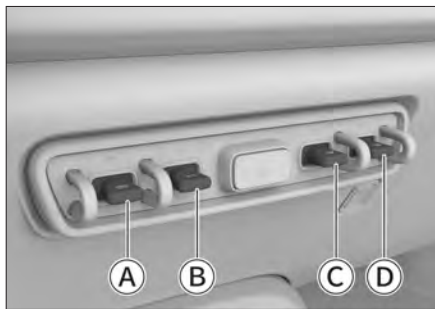

Please note that this manual describes all standard equipment, country-specific equipment and special equipment for this series. Therefore, some equipment or functions described in this manual may not be installed in your vehicle or only available in certain markets. To learn more about specific configurations, please refer to sales documents or consult the dealer where you purchased the vehicle.

A/C control screen



17F9C336624A

- (A) A/C On/Off button (ON/OFF)
 - (B) Cooling button (A/C)
 - (C) Windscreen defrost button
 - (D) Rear window defrost button
- › Press the **【ON/OFF】** button to switch the A/C system on or off.
 - › Press the **【A/C】** button to switch the cooling mode on or off. The corresponding light illuminates to indicate that cooling mode is on, which reduces the temperature and humidity in the vehicle.

- › Press the  windscreen defrost button to switch the windscreen defrost function on or off. The corresponding light will come on, indicating that the defrost function is on, and the windscreen and side door windows will gradually defrost or demist.
- › Press the  the rear window defrost button to switch the rear window defrost function on or off. The corresponding light will come on, indicating that the rear defrost function is on, and the rear window will gradually defrost.

WARNING

Once the rear defrost function is on, the window will become hot, do not touch it, and take care to avoid getting burnt.

CAUTION

If the vehicle has not started, please do not use the rear defrost function for extended periods to avoid draining the battery.

A/C settings screen

i NOTICE

Depending on model configuration, the multimedia screen menus and their operation may vary, please see actual vehicle for details.



13D0020EEEA2

- › Touch \odot off button to turn the A/C system off.
- › Touch the AUTO button to turn on automatic mode, which automatically adjusts the ventilation mode, fan speed, and switches between air recirculation and fresh air mode to achieve the set temperature.

i NOTICE

If the air-conditioning system auto-adjusted air pattern and volume do not meet your needs, you can adjust then manually. Exit auto-mode and the icon light will turn off.

- › Touch the A/C button to switch the cooling mode on or off. The corresponding light illuminates to indicate that cooling mode is on, which reduces the temperature and humidity in the vehicle.
- › Touch \odot heater button switches the heating mode on or off. When the corresponding light is illuminated, this indicates that heating mode is on.

i NOTICE



Due to different vehicle configurations, some models fitted with a heat pump and A/C system may not have this button.

- › Touch \curvearrowright face mode button, \curvearrowright face and feet button, \curvearrowright feet mode button or \curvearrowright the feet and defrost mode button selects the corresponding air distribution mode.

- › Touch ▲ warming or ▼ cooling button to adjust the temperature.
You can also adjust the temperature by swiping across the area between the ▲ warming and ▼ cooling buttons.

i NOTICE

When the temperature is adjusted to LO or HI, this can achieve rapid cooling or heating. The air-conditioning consumes more energy when this is the case, so we do not recommend using it for a long time.





- › Touch  windscreen defrost button to switch the windscreen defrost function on or off. The corresponding light will come on, indicating that the defrost function is on, and the windscreen and side door windows will gradually defrost or demist.
- › Touch  the rear window defrost button to switch the rear window defrost function on or off. The corresponding light will come on, indicating that the rear defrost function is on, and the rear window will gradually defrost.
The rear defrost function will automatically switch off after a period of time and the corresponding light will go out.

⚠ WARNING

Once the rear defrost function is on, the window will become hot, do not touch it, and take care to avoid getting burnt.

⚠ CAUTION

If the vehicle has not started, please do not use the rear defrost function for extended periods to avoid draining the battery.

- › Touch  Fan speed button, allows the fan speed adjustment screen to be displayed Touch or swipe the area within the fan speed adjustment screen, to adjust the fan speed.
- › Touch  air recirculation button or  the fresh air button to switch the A/C between air recirculation mode and fresh air mode.
 -  When the air recirculation light is on, air recirculation mode is on.
 -  When the fresh air light is on, fresh air mode is on. At this point, outside air is delivered into the vehicle.

i NOTICE

- › Under normal circumstances you should use the fresh air mode. Especially with the compressor switched off, using air recirculation mode can easily lead to the windows misting.
- › If the vehicle is stuck in a tunnel, or air quality outside is poor, or if you want to quickly cool or heat the vehicle, then you should use air recirculation mode.
- › If the air in the vehicle is muggy or if the vehicle is misty, switch to the fresh air mode.

More air-conditioning interface settings

Touch the ☺ more settings button on the A/C settings to see more options.

In the A/C more settings screen, you can switch automatic demisting on or off. When on, when the A/C is in AUTO mode, the system automatically adjusts the status of the A/C to prevent windscreen misting.

In the A/C more settings screen, you can switch the automatic low charge limiting function on or off; if the power battery charge is low, A/C use is then automatically limited.

A/C controller

Cooling/Heating

After starting the vehicle:

1. Select AUTO mode and the corresponding light will illuminate. At this time, the compressor or heater will be automatically switched on or off depending on temperature and environmental factors.
2. Set the temperature as desired and the A/C system will automatically adjust the ventilation mode and fan speed to reach the set temperature.
3. Selecting air recirculation mode can speed up cooling or heating, which will help improve economy as well as comfort within the vehicle.

NOTICE

Turning on air recirculation when heating in the winter can easily cause the windows to fog up, so be sure to defog.

Front defrost/front defog

After starting the vehicle:

1. Select pre-defrost mode and the corresponding light will illuminate.
2. You may adjust the fan speed, temperature, switch the A/C on or off and switch between air recirculation/fresh air mode as needed.

NOTICE

If the air in the vehicle is humid or the vehicle mists up, we recommend that

you switch to fresh air.

CAUTION

- › Regularly check the radiator and A/C condenser. Use a low-pressure washer or soft brush to remove leaves, insects and dust that have accumulated on the front surface. Otherwise, these objects may obstruct the airflow, reducing the cooling effect.
- › Regular use of the A/C will keep the compressor and seals well lubricated and prevent leakage. Therefore, even in cold seasons when air-conditioning is not required, the air-conditioning needs to be turned on at least once a week for at least 10 minutes each time.
- › If the A/C cooling effect weakens, go to an authorised service centre for service.
- › Direct release of refrigerant into the atmosphere is environmentally harmful, and refrigerant should be recovered in suitable containers by trained and qualified technicians.

NOTICE

A/C odours

› Sources of odours

A/C requires exchange of internal and external air. After lengthy use it can easily gather dirt, and mildew can develop after long periods, resulting in bad odours.

After extended periods, the A/C filter can absorb water, and dust, resulting in odours.

› Recommended measures

When the outside air is fresh, use fresh air mode to ensure the vehicle interior remains ventilated.

We recommend that you first switch off the air-conditioning compressor (A/C), then keep the fan running for three to five minutes then switch off the air-conditioning system, so as to dry the air-conditioning system and prevent the growth of mould.

If you detect a strong odour, we recommend that you go to an authorised service centre for service and, if necessary, cleaning or replacement of the A/C filters.

Cabin air refresh

The cabin air refresh function enables you to refresh the air in your vehicle remotely through a mobile app before entering the cabin.

The cabin air refresh function will automatically shut down after a short period of time or when the vehicle door is opened.

i NOTICE

When using the cabin air refresh function, you need to ensure the following conditions are met:

- › There is a clear network signal for

the vehicle SIM card.

- › The power supply is in OFF mode and all doors are closed.

⚠ CAUTION

- › To avoid draining the battery, the vehicle automatically switches to READY mode when the cabin air refresh function is switched on.
- › Do not use this function if air quality outside the vehicle is poor.

Air vents

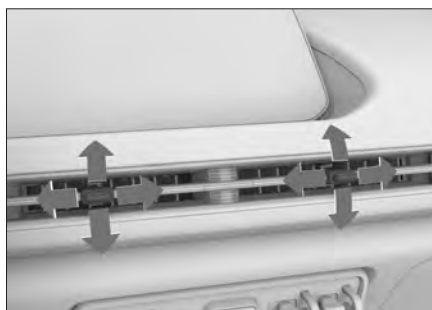

D32D152F8836

Move the slider in the middle of the outlet vent to adjust the direction of airflow. Move the slider in the direction towards the right hand closed symbol, once it reaches the limit the vent will close.

Mobile phone wireless charging

Vehicle equipment

Please note that this manual describes all standard equipment, country-specific equipment and special equipment for this series. Therefore, some equipment or functions described in this manual may not be installed in your vehicle or only available in certain markets. To learn more about specific configurations, please refer to sales documents or consult the dealer where you purchased the vehicle.

Usage

You can turn mobile phone wireless charging on or off in **【Vehicle Settings】** → **【In-Car】** → **【Wireless Charging】** on the multimedia screen.

After switching on the mobile phone wireless charging function, ensure that vehicle doors are closed, the main vehicle power supply is switched to ON mode or the vehicle is started, then a mobile phone placed in the charging area can be charged.



i NOTICE

For better charging, make sure the charging coil of the mobile phone is facing downwards.

i NOTICE

- › This function does not apply to all mobile phones, it only applies to those with the officially recognised "Qi" standard when correctly placed in the charging area.
- › Only one mobile phone can be charged at a time.
- › On bumpy roads, there may be some interruptions to wireless charging. If the mobile phone shifts out of the charging area and charging stops, it needs to be put back into the charging area.
- › When charging, the wireless charger and the mobile phone will become hot, this is normal. If it gets too hot the system stops charging and resumes charging when it cools.
- › If the mobile phone is faulty it might not be capable of charging in this manner. You can use a similar mobile phone to check wireless charging and to confirm whether your mobile phone has a fault.
- › If the mobile phone has a protective cover or attachment that does not support wireless charging, you should remove it first, otherwise

charging will not function correctly.

- › To avoid draining the battery, do not use wireless charging for long periods without starting the vehicle.

WARNING

- › For safety reasons the driver should not carry out charging operations while driving.
- › Do not place metallic items such as coins, keys or microchip cards, in the charging area. Metallic article may become hot and can prevent normal charging or represent a safety risk. If a metal object is located in the charging area while charging, to avoid burning your fingers, do not remove it immediately using your hand. The wireless charging function should be switched off immediately, then the object removed after waiting a few minutes.
- › If you need to use the charging area as a storage box, please switch off the wireless charging function.

CAUTION

- › Do not spill any liquid on the charging area, to avoid it getting into the wireless charging system through gaps in the rubber mat which could cause a fault.
- › Do not modify the wireless charging system as this could damage the vehicle or be dangerous.

Interior fittings

Vehicle equipment

Please note that this manual describes all standard equipment, country-specific equipment and special equipment for this series. Therefore, some equipment or functions described in this manual may not be installed in your vehicle or only available in certain markets. To learn more about specific configurations, please refer to sales documents or consult the dealer where you purchased the vehicle.

Sun visors

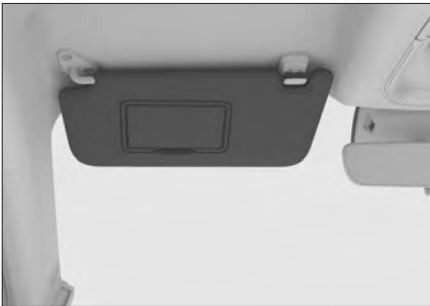

To get shade from head-on sun, simply flip the sun visor down.



To get shade from side-on sun, simply flip the sun visor down, detach from the

hook, and turn it to the side.

Vanity mirror

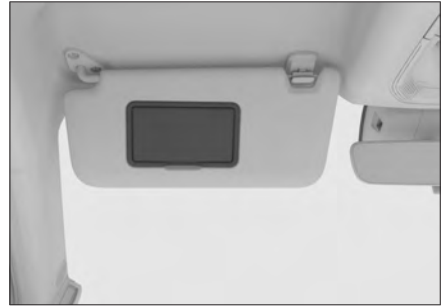

There is a vanity mirror inside the sun visor. Open the cover to use it.

When not using the vanity mirror, please close the cover.

Storage

Glove box

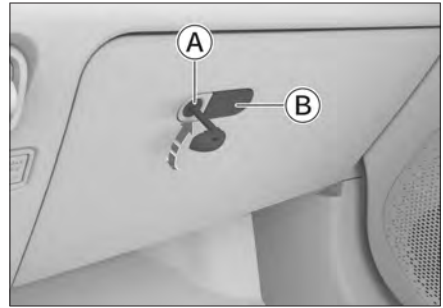

Ⓐ Glove box lock

Ⓑ Glove box opening button

Insert the mechanical key into the lock of the glove box. Rotate the key to lock or unlock the glove box.

After unlocking, press the glove box opening button. The glove box will open automatically.

When the glove box is open, push it upwards to its locking position to close it.

⚠ WARNING

When driving, ensure that the glove box is closed. Otherwise, in the event of an accident or if you brake suddenly, the contents of the glove box may fly out, causing injury.

Storage box



A storage box is provided under the armrest of the front seat. Swing the seat armrest upward to open it.

Glasses compartment



Press on the glasses compartment to open it.

⚠ WARNING

When driving, make sure that the glasses compartment is closed.

i NOTICE

Some large sunglasses may not fit inside the compartment.

Cup holder



The front cup holder is located on the centre console in the position in the diagram.

⚠ CAUTION

- › Do not place drinks cans that are too small or unstable in the cup holder in case they spill.
- › Make sure the tops of utensils are closed to prevent spillage.

Bottle holder

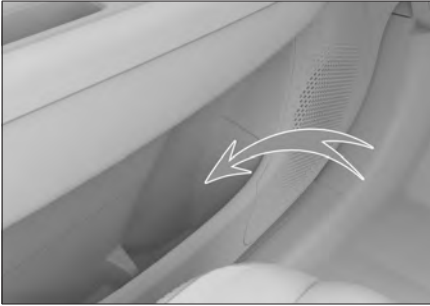

627E2CD5C0A0

Each door has a bottle holder on the inner side. It is only for sealed bottles.

⚠ WARNING

Do not place anything other than bottles in the bottle holder. Otherwise, in the event of an accident or sudden braking, the article may be thrown from the bottle holder and cause injury.

⚠ CAUTION

Make sure that the bottle cap is shut to prevent spillage.

Power supply socket

USB power socket

Located near the centre console front

cup holder.

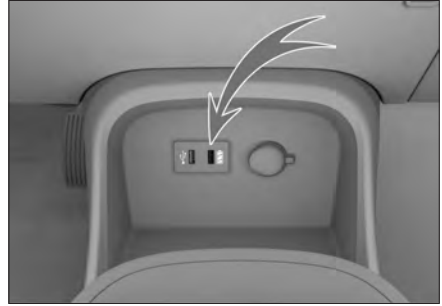

B1866718FB55

Located to the rear of the centre console.

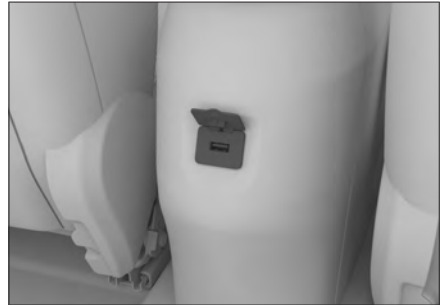

C5DA9CBE1FA3

With the power supply in ON mode, simply open the cover to use.

This power supply can be used for charging mobile phones, tablets, and other electrical devices.

Backup power supply



6CECFA92EE2F

Located near the centre console front cup holder.

With the power supply in ON mode, simply open the cover to use.

This power supply provides 12-volt DC power for accessories rated ≤ 120 watts (10 amps).

WARNING

Inflammable gas and heat sources should be kept away from power sockets.

CAUTION

- › Do not allow liquids such as drinks or foreign matter to enter power supply sockets; otherwise a short-circuit or other fault could easily occur. If the power supply socket has a protective cover, replace the protective cover when not in use.
- › If you use an accessory which exceeds the power rating, you may blow a vehicle fuse.
- › Do not connect precision devices, strongly inductive devices, or other important device to this power supply socket.
- › Do not use this power supply in damp or high temperature conditions.
- › Do not connect in parallel or series with any other power supply.
- › If any abnormality occurs during use (abnormally high temperature,

smoke, odours, etc.), please immediately stop usage and go to an authorised service centre as soon as possible for repair.

- › Unauthorised customisation or repair of this power supply system is prohibited.
- › When external cables are connected, ensure these are waterproof and sealed properly.

2

Driving

| | | | |
|---|-----|-------------------------------|-----|
| Driving procedures..... | 80 | Driving assistance systems . | 141 |
| Driving in adverse weather conditions | 85 | Virtual instruments | 144 |
| Running-in | 90 | Instruments panel lights..... | 148 |
| Pure electric vehicles | 91 | Power management system | 155 |
| Vehicle power supply | 97 | | |
| Parking brake | 99 | | |
| Gearbox | 102 | | |
| Driving mode..... | 106 | | |
| Acoustic vehicle alert system | 109 | | |
| Power assisted steering mode | 110 | | |
| Parking assist system..... | 111 | | |
| Tyre pressure monitoring system | 119 | | |
| Intelligent monitoring system | 121 | | |
| Cruise control assist system | 123 | | |
| Intelligent driving assistance system | 129 | | |

Vehicle equipment

Please note that this manual describes all standard equipment, country-specific equipment and special equipment for this series. Therefore, some equipment or functions described in this manual may not be installed in your vehicle or only available in certain markets. To learn more about specific configurations, please refer to sales documents or consult the dealer where you purchased the vehicle.

Before driving

Remove any foreign debris

Before driving, thoroughly remove snow and fallen leaves from the vehicle body.

Check the condition of the vehicle

Before driving off please make a daily check of tyres, oil, lights and the body-work to ensure safe driving.

Before driving please check the power battery charge and range to ensure that the vehicle can reach its destination.

If you feel your vehicle needs repair, please contact an authorised service centre as quickly as possible.

Confirm the doors and the bonnet are closed

Before driving check that all doors are closed. If a door is not properly closed it could open suddenly while driving, and could result in an accident.

If the bonnet was opened before driving

off, you should confirm that it is secured. If the bonnet is not properly secured, it might suddenly open while driving, and could result in an accident.

Placing items inside the vehicle

On the dashboard

Do not place items on the dashboard, as this will not only hinder the driver's view, but will also affect driving and the safety of the vehicle and could result in an accident.

Driver's foot well

Do not place any item in the driver's foot well. Items placed in the driver's foot well can easily get caught under the pedals, which might lead to the driver losing control of the vehicle, and could result in an accident.

If you need to install floor mats, please use the floor mats suitable for this vehicle. If floor mats are the wrong shape, not laid correctly or are double-layered, this will affect the operation of the pedals, which could lead to problems starting the vehicle or difficulties changing gear, and could result in an accident.

Under the seats

Do not place any items under the seats. Items placed under seats can affect the position of the seat or the prevent it from being locked in position, which could result in an accident.

Seat backs

Please do not place cushions or other

items between your back and the seat back. Apart from affecting correct driving position, in the event of a collision the seat belt and headrest will not function properly and provide the level of protection needed, which could result in serious and life-threatening injuries.

Window glass

Do not stick suction pads or similar items on to the window glass.

Suction pads act like lenses and could cause a vehicle fire.

While driving

Do not exceed the speed limit

When driving do not exceed the speed limit indicated by signs or other marking.

Do not overload the vehicle

Driving a vehicle that is over-loaded is very dangerous.

When driving you must not carry more than the permitted number of passengers or exceed the weight limit. Passengers should not ride in the luggage compartment.

Do not drive when tired

It is extremely dangerous to drive when tired, as the driver's judgment, vision and attention will be greatly reduced, and this can easily cause a serious accident.

Do not turn the steering wheel to full-lock for a long time.

If you apply full-lock to the steering

wheel for a long period, this could cause a reduction in the effectiveness of the power steering system and could damage the system.

Do not apply the brakes for extended periods.

While driving, do not continuously press the brake pedal or apply the parking brake. This increases wear on the brake pads, or can cause the brakes to over-heat, affecting braking efficiency, which could easily result in an accident.

Brake warning sound

A metallic grinding or squealing noise will be emitted when the brake pads on disk brakes are worn to the extent that they need replacing.

If you hear a vibration while braking, do not continue driving. Otherwise serious damage to the brakes and brake disks can occur, which could result in an accident.

Punctures

Do not continue to drive with a puncture. It is very dangerous to drive with a puncture; this could easily result in an accident. Damage to the tyres, the wheels, the suspension and the vehicle body could also occur. The tyre should be replaced immediately.

You will need to check to see whether the tyre has a puncture or is split when any of the following occur:

- › If the steering wheel shakes.

- › If the vehicle vibrates abnormally.
- › If the vehicle tilts abnormally.

If a puncture or a split in a tyre occurs while driving, hold the steering wheel firmly and press gently on the brake pedal to slow down. Sudden braking or violent adjustments to steering can easily cause loss of control of the vehicle.

Strong impacts on the underbody, tyres or rims

In case of a strong impact on the underbody, tyres or rims, immediately park in a safe place and carry out an examination. Check whether there is any brake fluid leak or any distortion or damage to parts such as the suspension, tyres, rims or powertrain system. If you find any leak or damage, immediately park the vehicle and contact an authorised service centre.

Do not switch the vehicle power supply mode to OFF when going downhill.

If you switch the vehicle power supply mode to OFF, the brake boost and power steering systems will not work, which will reduce braking performance and make the steering heavy, increasing the risk of an accident.

Driving on road surfaces with height differences

When stopping the vehicle by a kerb or on a road surface with a height difference, make sure that the tyres are not squeezed or deformed from being

pressed against the kerb or other obstruction.

When it is necessary to drive over a kerb, a speed bump or similar obstruction, as far as possible, try to drive slowly at a right angle to the obstruction. Failure to do so may result in damage to the tyres, especially the side walls.

The bumper is liable to be damaged when driving in the following areas or when affected by the scenarios. Slow down and drive with caution.

- › Carpark entrances and exits with steps or slopes.
- › Multi-storey carparks with sharp bends and sections with steep slopes.
- › Uneven road surfaces and road sections with wheel ruts from other vehicles.
- › Road sections with potholes.
- › When driving from a flat surface on to a ramp, or from a ramp onto a flat surface.
- › When parking on a road with speed bumps or along a kerb.

When driving on slippery road surfaces (wet, snowy or icy)

Sudden braking, rapid acceleration and violent steering on slippery road surfaces can easily cause skidding and loss of control of the vehicle, thus causing accidents.

In cold weather slow down and drive slowly across bridges, areas covered by

a shadow and other places prone to ice.

Driving on flooded roads

Take care when driving on flooded roads and avoid going along roads with excessive flooding.

When driving on flooded roads the power battery pack, the motor controller and other parts of the electrical power system could suffer serious damage.

When driving on flooded roads the brake pads will get wet, which will weaken the effectiveness of braking and could result in an accident. Repeatedly and gently press the brake pedal to heat the brakes until you can confirm they are functioning normally.

Precautions for passengers

Do not move around inside the vehicle

Passengers should not leave their seats or move around inside the vehicle. Otherwise, they may be seriously injured by impact to their body and head caused by emergency braking.

Do not stick hand or head out of car window or sunroof

Sticking hand or head out of car may strike the window frame during emergency braking or when closing the window, and this may cause serious injury or even death.

Do not hold a child on your lap

When riding in the vehicle, do not hold an infant or child on your lap even if you

are wearing your seat belt, and do not wrap the seat belt around any part of an infant or child. Otherwise, it may cause serious or fatal injury to infant or child during a collision or during emergency braking.

Do not allow children to operate vehicle doors, windows or the sunroof

Children are likely to trap their hand, head or neck when operating a vehicle door, window or sunroof, which could result in serious personal injury.

If the child was to open a door while the vehicle is moving, they could be thrown out of the vehicle, resulting in serious personal injury or even death.

Use the child safety lock and window lock to prevent children from causing an accident.

Parking the vehicle

To ensure the performance of the vehicle and the life of the power battery, the vehicle should be parked in a dry, ventilated, shaded space at suitable temperatures.

Do not park near inflammable objects

Do not park on roads with large quantities of flammable items such as grass or paper litter, as these might cause a fire.

Do not park near sources of high temperatures

Do not park near any high-temperature source of ignition or naked flames, as this could cause a dangerous incident.

Economical driving

Predictive driving

Maintain an appropriate distance from the vehicle in front to avoid unnecessary acceleration and braking. Maintaining a steady vehicle speed can increase range.

Avoid unnecessary loads

Driving with heavy loads or over-loaded will increase power consumption. Before driving, please remove unnecessary items from the vehicle.

Regularly check tyre pressure

Low tyre pressures will increase road resistance and energy consumption and at the same time increase tyre wear.

Regular maintenance and servicing

Regular maintenance of your vehicle will ensure your vehicle has a long life and provides the most economical performance.

Sensible use of air-conditioning

The use of A/C or heating can reduce the range of your vehicle. When the power battery charge is low, it is recommended to reduce the use of A/C to increase the range of the vehicle.

The A/C temperature should not be set too cold or too hot; please set an appropriate temperature to reduce energy consumption.

Please switch off the A/C as soon as it is not needed.

Closing the windows and sunroof

Opening a window or the sunroof increases wind resistance and thus energy consumption, so please keep them closed unless necessary.

Coast in gear to maintain speed

When approaching a red light or going down a steep slope, release the accelerator pedal and coast while staying in gear.

Vehicle equipment

Please note that this manual describes all standard equipment, country-specific equipment and special equipment for this series. Therefore, some equipment or functions described in this manual may not be installed in your vehicle or only available in certain markets. To learn more about specific configurations, please refer to sales documents or consult the dealer where you purchased the vehicle.

Driving in fog

Turning on fog lights

You should turn on the fog lights when driving in fog.

Use the horn to warn pedestrians and other vehicles

When you hear the horn of other vehicle, you should also honk the horn immediately to indicate the location of your vehicle.

Drive at a lower speed and with caution

You should try to drive at a lower speed in fog and maintain a safe distance from the vehicle in front of you.

Do not wipe off fog from the car windscreen and windows while driving

Due to the significantly different temperature between inside and outside of the vehicle, often a thin layer of fog forms on the interior of the windscreen, affecting the driver's field of vision. By using

the defrost function of the air-conditioning or by slightly opening a window to balance the inside temperature with the temperature outside, you can avoid having this layer of fog form on the inside of the windscreen.

If you would like to wipe off the fog on the windscreen, first park the car and then wipe the window.

Driving in the rain

Safe driving on slippery road surfaces

Poor visibility, a fogged windscreen and slippery roads often occur while driving in the rain. Drive with caution.

When performing emergency braking, steering and accelerating on a slippery road, tyres may slip, making it difficult to control the vehicle, which may lead to an accident.

A film of water is likely to form between tyres and the ground when driving in the rain, causing tyres to lose traction.

Please drive more slowly.

WARNING

Avoid driving in heavy rain.

Driving through water

Precautions to take when driving through water

- › Before driving through water, determine the depth of the water on the road, it should not reach higher than the bottom of the car body. If the water is too deep, or the depth is

unknown, make a detour, do not attempt to drive through it.

- › Check the condition of the road, do not take vehicles into unknown areas, which might have hidden obstacles such as ditches or manholes, etc.
- › When driving through water, drive slowly (no faster than 10 km/h) and do not stop or change gear.
- › When crossing a road junction avoid the front grille being submerged by waves created by passing vehicles.

Inspect the vehicle after driving through water

Once the vehicle is safely through the water immediately do the following:

- › Press the brake pedal gently several times to check that the brakes are functioning correctly.
- › Check the horn.
- › Check all the vehicle lights.
- › Please go to an authorised service centre as soon as possible for a routine check. While the vehicle was driving through water, water could have entered the transmission system, contaminating the lubricant grease, and might cause a system fault.

⚠ CAUTION

- › Driving through water should only be attempted in emergencies and not as part of routine driving.
- › Driving through water can damage the electric motor controllers, the

power battery pack, the transmission system and other parts, and lead to serious damage to the vehicle.

Driving in hot weather

High temperatures and hot weather may have a negative impact on normal operation of the vehicle as well as on driver health. To ensure vehicle safety, the driver should pay attention to the following points:

Avoid blowouts

Tyre pressures increase as temperature rises and high temperatures in hot weather make tyres more prone to blowouts, increasing the risk of accidents.

If a blowout occurs while driving, hold the steering wheel tightly and use the brake pedal to slow down, but avoid harsh braking and sharp steering, otherwise, you could easily lose control of the vehicle.

Preventing heatstroke

In hot weather with strong sunlight and high temperatures, heat stroke can easily occur. Keep the vehicle cabin well ventilated and do not drive when tired.

⚠ WARNING

- Do not lock unaccompanied children in vehicles.
- › If children are left alone in a vehicle during hot weather, they can easily

develop heat stroke or become dehydrated, which can lead to injury or even death.

- › If children are left alone in the vehicle, there is a risk they may play with matches or cigarette lighters, and could easily cause a vehicle fire.

CAUTION

Do not leave cigarette lighters, spray cans, drinks cans, or glasses, etc. inside the vehicle.

- › High temperatures within the vehicle could cause gas leaking from cigarette lighters or spray cans to ignite.
- › If a drinks can ruptures the liquid could easily cause a short-circuit when it comes into contact with electric power components.
- › Due to the high temperatures within the vehicle, resin lenses or glasses can easily be damaged.

Driving in cold weather

Winter tyres

In cold weather, the flexibility and grip of standard tyres is reduced due to their particular characteristics (tyre width, composition and tread, etc.), and tyre rumble will increase. In serious cases, permanent damage such as cracks and abnormal wear may occur to standard tyres. Therefore, use winter tyres when the temperature falls below 7°C. Winter tyres can greatly improve handling and

can also improve braking responsiveness, thus reducing braking distance.

NOTICE

Although all-season tyres marked M+S have quite good cold weather performance, generally speaking, their performance is not as good as winter tyres and should be replaced with winter tyres when driving on snow or ice.

WARNING

While winter tyres improve the vehicle's grip, you should still drive carefully and remain cautious.

- › Be sure to adjust your speed and driving style taking into account visibility, weather, road and traffic conditions.
- › Do not exceed the vehicle speed and load rating of your winter tyres.

CAUTION

Winter tyres lose their effectiveness if there is severe wear to their tread. The same is true if the winter tyres are aged, even if the tread is not worn out. For specific replacement standards for winter tyres, consult a dealer.

Using winter tyres:

- › Winter tyres must comply with the local country's laws and regulations.
- › Winter tyres must be fitted to all four wheels at the same time.

- › Winter tyres must be the same size as the standard tyres.
- › All four winter tyres must be of the same model, size (circumference) and tread type.
- › Winter tyres should be used only during cold weather.
- › Be sure to comply with all maximum limits for winter tyres (maximum speed, maximum load, etc.), or damage could occur to the tyres, causing an accident.
- › Do not reverse the direction of the tyres' rotation.

Snow chains

The use of snow chains is determined by the standards currently in place in different countries and regions. The installation of snow chains must comply with local laws and regulations.

Snow chains can only be attached on the drive wheels and should not be attached to just one wheel. When attaching the chains, follow the instructions provided by the manufacturer and ensure they are tightened appropriately.

CAUTION

When attaching snow chains take note of the following precautions:

- › The wrong size or improper attachment of snow chains can damage the vehicle's brake lines, suspension, body and tyres. Choose suitable snow chains and ensure correct

mounting.

- › When attaching snow chains, park the vehicle on a level surface away from traffic, switch on the hazard warning lights and place a warning triangle behind the vehicle.
- › Before attaching the snow chains you must switch the power supply mode to OFF and apply the parking brake.
- › Do not attach snow chains to the emergency wheel or a smaller spare tyre.
- › Do not attach snow chains to tyres that have low tyre pressure.
- › When using snow chains be careful not to damage the alloy wheel rims.

WARNING

When driving a vehicle with snow chains, take note of the following precautions:

- › After the snow chains have been attached, drive no faster than 40 km/h or the maximum speed recommended by the snow chain manufacturer, whichever is lower.
- › After driving for 0.5-1 km with the snow chains attached, check whether they have been correctly attached to ensure safety. If the snow chains become loose, tighten or reattach them.
- › After attaching the snow chains, vehicle control may be adversely affected. Avoid hard acceleration, sharp

steering and hard braking to the extent possible, otherwise an accident could occur.

- › If you hear the snow chains knocking against the body or the underside of the vehicle, stop the vehicle as soon as possible to check and tighten them. If there is still noise, slow down until the noise stops.
- › Avoid driving on bumpy road surfaces or roads with potholes.
- › Before taking a bend in the road, reduce speed to maintain control of the vehicle.
- › The snow chains should be removed as soon as possible on snow-free roads, otherwise they will affect driving performance and seriously damage the tyres.

Vehicle equipment

Please note that this manual describes all standard equipment, country-specific equipment and special equipment for this series. Therefore, some equipment or functions described in this manual may not be installed in your vehicle or only available in certain markets. To learn more about specific configurations, please refer to sales documents or consult the dealer where you purchased the vehicle.

Tyres

Be especially careful for the first 500 km when using new tyres.

New tyres have a lower grip performance and need to be run in.

Brake pads

New brake pads need to be used for 400 km of driving before reaching their optimal braking performance.

New brake pads need to be worn in to maximise their frictional force. However, pressing harder on the brake pedal compensates for the lower brake force.

Avoid additional loads on the brakes during the run-in period. This includes emergency braking, especially when the vehicle is moving at a high speed, and emergency braking when driving on a slope.

experience different levels of wear.

The amount of wear depends, to a large extent, on how they are used and how the vehicle is driven.

- › Based on the vehicle speed, brake force and environmental factors (for example, temperature and humidity), the brakes may make noise, which is completely normal.

CAUTION

- › Brake pads and brake discs

Vehicle equipment

Please note that this manual describes all standard equipment, country-specific equipment and special equipment for this series. Therefore, some equipment or functions described in this manual may not be installed in your vehicle or only available in certain markets. To learn more about specific configurations, please refer to sales documents or consult the dealer where you purchased the vehicle.

Power battery recycling

When you need to replace or scrap the power battery please be sure to check recycling requirements with an authorised service centre. Careless disposal of the power battery will cause environmental pollution and can be dangerous.

WARNING

- › Do not sell, transfer or modify the power battery.
If the power battery is used outside the vehicle or is modified there is a risk of electric shock, overheating, smoking, electrolyte leakage or explosion.
- › Please do not handle the power battery yourself; this could cause environmental damage and there is a danger of electric shock.
- › To ensure your safety, under no circumstances should you open or modify the power battery pack. If you need to repair, disassemble, replace or scrap the power battery this should be handled by an authorised service centre.

About pure electric vehicles

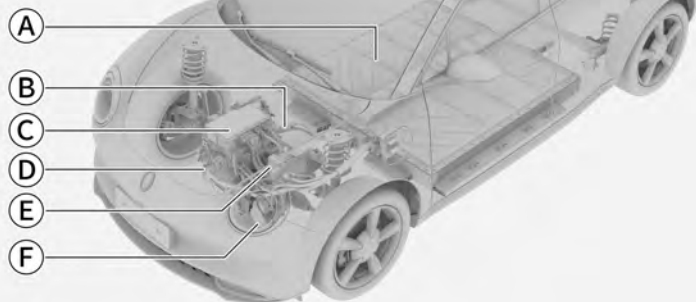

9B3D438AA912

- Ⓐ Power battery
- Ⓑ High-voltage wiring
- Ⓒ Charger
- Ⓓ Drive motor
- Ⓔ A/C heater
- Ⓕ A/C compressor

This vehicle is a pure electric vehicle, and a high-voltage power battery is used as the energy storage medium. In order to ensure safe use of the vehicle and extend its life, it is necessary to be familiar with the characteristics of pure electric vehicles and drive cautiously.

⚠ WARNING

- › To prevent high-voltage electric shock, do not touch, disassemble or replace vehicle components with high-voltage warning labels affixed, or orange power cables and their connections.
- › After the vehicle is started, the powertrain system will be very hot. Beware of high voltages and temperatures, and always follow the instructions on the vehicle safety warning stickers.

⚠ CAUTION

- › Do not leave the vehicle in a high temperature environment above 45°C for more

than 1 day. Move the vehicle to a cooler environment as quickly as possible, otherwise the performance of the power battery may be affected.

When the power battery temperature is too high, energy recovery and the output rating will decrease. In serious cases, the high-voltage power will be cut by the system.

- › When the vehicle is used at low temperatures, range will be reduced due to the effects of low temperatures on power battery performance.
- › When the power battery temperature is too low, the system will cut high-voltage power. If necessary, use slow AC charging to preheat the battery.
- › Long-term use or abuse of the battery can affect the performance and lifetime of the power battery, and lead to reduced range.

Battery thermal runaway warning

When the vehicle battery management system detects thermal runaway in the battery pack, the batteries will automatically cut the power supply. Five minutes before there is any danger the instruments will issue a text-based and audible warning in the passenger cabin. Passengers should exit the vehicle as quickly as possible.

Charger temperature regulation function

Function overview

If the ambient temperature of the vehicle is lower than -15°C or higher than 35°C , charger temperature regulation keeps the temperature of the battery within the appropriate range. This improves vehicle performance and range.

Usage

The charger warming/cooling function can be turned on or off in **【Power Assistant】** → **【Charging Management】** on the multimedia screen.

NOTICE

You must use the charging cable that came with the vehicle to use charger temperature regulation. Otherwise, this function will be unavailable.

We recommend turning this function off if the ambient temperature is between -15°C and 35°C .

Energy recovery

The main purpose of this function is to convert part of the kinetic energy from braking or movement into electrical energy for the power battery. This extends the vehicle's range.

The energy recovery level can be set in **【Vehicle Settings】** → **【Driving】** on the multimedia screen.

NOTICE

When single pedal driving is on, the energy recovery level is not adjustable.

WARNING

The decrease in vehicle speed caused by energy recovery cannot take the place of normal braking. To decelerate and stop the vehicle, you must press on the brake pedal.

NOTICE

When energy recovery is activated, causing significant deceleration, the brake lights can come on.

NOTICE

Energy recovery will not take place under the following circumstances:

- › When the vehicle is in Neutral or Reverse.
- › When the power battery is fully charged.
- › When the temperature of the power battery is too high or too low.
- › When the temperature of the drive motor is too high.

WARNING

When driving and not recovering energy, always be prepared to brake because the electric powertrain system does not decelerate the vehicle when not using energy recovery. Avoid unnecessary hazards caused by the

vehicle continuing to roll forward.

Battery safety switch



BD4705FF671D

The battery safety switch is positioned next to the support rod in the engine compartment and is visible after opening the bonnet. This switch is used to disconnect or connect the high-voltage system and power battery.

WARNING

Do not try to operate the battery safety switch in the engine compartment. The battery safety switch is only used during maintenance and when performing operations associated with the high-voltage system.

High-voltage warning labels

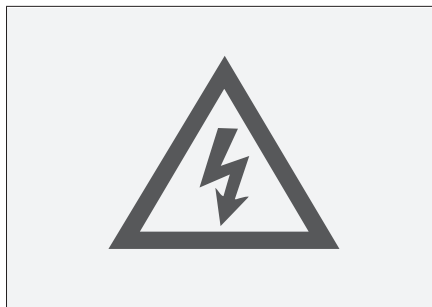

0E59F636B839

This label is located on the charging port cover to warn you that there is high-voltage electricity present; unauthorised disassembly, repair or replacement is not permitted. Please take note of this, otherwise, there is a risk of electric shock.



D12A82022FAF

There are also labels on high-voltage components to remind you that

- › such components use high-voltage electricity.
- › Unauthorised disassembly, repair or replacement is not permitted. Please take note.
- › Do not ever touch high-voltage components, otherwise there is a risk of an electric shock.

 **WARNING**

All parts in the vehicle with a high-voltage warning label attached can only be worked on by qualified staff.

Do not let fingers, tools, jewellery or other metallic objects come into contact with components which have high-voltage warning labels attached to them.

Gas that leaks or escapes from the power battery pack may be toxic or flammable. In case of an accident, please stay away from the vehicle to prevent personal injury or even death.

Vehicle equipment

Please note that this manual describes all standard equipment, country-specific equipment and special equipment for this series. Therefore, some equipment or functions described in this manual may not be installed in your vehicle or only available in certain markets. To learn more about specific configurations, please refer to sales documents or consult the dealer where you purchased the vehicle.

Vehicle power supply

Turning on the power supply

Use the smart key or intelligent entry system to unlock the doors. Open the driver's door, then switch the vehicle power supply to the ON mode to turn on all low-voltage electrical components.

Starting the vehicle

When the following conditions are met and the brake pedal is depressed, the vehicle will turn on (the READY light is illuminated).

- › The driver is carrying the intelligent key.
- › The driver is seated in the driver's seat or the driver's seat belt is fastened.
- › The vehicle is in Neutral or Park.
- › Electronic steering is unlocked.

Emergency starting



If the vehicle prompts, "Is your key in the vehicle" (e.g., the intelligent key has lost power or there is severe damage to the door guard or rear bumper), place the intelligent key in the instrument panel storage box above the  logo. Then, by pressing the brake pedal you will be able to start the vehicle. If the vehicle will not start, contact an authorised service centre as soon as possible.

WARNING

- › You must sit in the driver's seat to turn on the vehicle. otherwise, a serious or fatal injury could occur.
- › If you need to move the vehicle slightly, you must start the vehicle first, Otherwise, an accident may occur.

NOTICE

If the instruments panel shows that the electronic steering failed to unlock, follow the instructions to turn the steering wheel. After unlocking, you may

start the vehicle.

Turning off the power

- › The vehicle's power supply will be switched to OFF mode after the vehicle is stopped, the gear is changed to P, all doors and the boot lid are closed and the doors are locked using the smart key or the smart entry system.
- › After stopping the vehicle, press the (N) power supply OFF button to switch the vehicle power supply off.



86E2E94F527A

Emergency power off

If the vehicle is moving (speed greater than 5 km/h) and there is an emergency, for example, the vehicle cannot be stopped normally, long press the (N) power supply OFF button for 5 seconds to switch the vehicle power supply off.

⚠ WARNING

- › Shutting off the vehicle while driving may cause a collision or serious personal injury.
- › Do not switch the vehicle power supply to the OFF mode while driving

unless it is an emergency.

Otherwise, the brakes and steering will be turned off, making braking and steering much more difficult. Therefore, slow down as much as possible before turning off the power.

Vehicle equipment

Please note that this manual describes all standard equipment, country-specific equipment and special equipment for this series. Therefore, some equipment or functions described in this manual may not be installed in your vehicle or only available in certain markets. To learn more about specific configurations, please refer to sales documents or consult the dealer where you purchased the vehicle.

Safety notice

WARNING

- › Stopping the vehicle on a steep slope increases the risk of an accident. Drive safely and avoid such risky stops.
- › The parking brake is not capable of completely preventing the vehicle from rolling on very steep slopes, so press down the brake pedal as well to prevent the vehicle from rolling.

Electric parking brake

Apply the parking brake



2554C150C674

- › When the vehicle is stopped, pull up the EPB switch to apply the electric parking brake (EPB). At this point, the (P) parking brake light on the instruments cluster will come on.
- › When the vehicle is stopped, the electric parking brake is automatically applied when the driver's door is opened and the driver's seat belt is unbuckled. At this point, the (P) parking brake light on the instruments cluster will come on.

If you do not wish the parking brake function to apply after the vehicle is closed, you need to switch to Neutral, press the EPB switch and press (N) the power supply off button.

Emergency braking

In an emergency, pulling up the EPB switch and then holding it up will cause the EPB system to brake the vehicle. The instruments cluster will emit a warning.

Simply release the EPB switch or press the accelerator pedal to cancel emergency braking.

⚠ WARNING

The emergency braking function of the EPB system should only be used in an emergency (such as when the brake pedal is obstructed).

Releasing the parking brake



D013B185FF06

When the vehicle power supply mode is ON, pressing on the brake pedal and pushing down the EPB switch releases the parking brake. At this point, the (P) parking brake light on the instruments cluster will turn off.

i NOTICE

In the event of abnormal interruption in vehicle power, when power is restored, the parking brake error light on the instruments cluster (P) will illuminate. At this time, the system needs to be restarted. First pull up the EPB switch, then press the brake pedal and press on the EPB switch to release the

EPB normally.

When in Park, you cannot manually release the EPB.

Auto vehicle hold (AVH)



C54DF885B16C

When the vehicle is on a slope and encounters a red light or is driving in stop-and-go traffic, auto vehicle hold (AVH) frees the driver from having to keep their foot on the brake pedal for long periods or repeatedly apply the electric parking brake. This enhances the comfort of the driver, and can also reduce the risk of the vehicle rolling back.

After closing the driver's door, fastening the driver's seat belt, and starting the vehicle, press the AVH button to turn the auto vehicle hold function on or off.

Usage

1. Turn on the auto vehicle hold (AVH) function. At this point, the auto vehicle hold function is in the ready state, and the auto vehicle hold light on the instruments cluster (P) is yellow.
2. Stop the vehicle by pressing the brake pedal, and the vehicle will

automatically apply the parking brake. Now, the auto vehicle hold function is operational, and the auto vehicle hold light on the instruments cluster  is green.

3. When in Drive or Reverse, press the accelerator pedal and the parking brake will release automatically. If the accelerator pedal is not pressed for a long time, the auto vehicle hold function will turn off, and the electric parking brake will be automatically applied.

The following conditions will force the auto vehicle hold function to be exited:

- › Releasing the driver's seat belt.
- › Opening the driver's door.
- › Switching the vehicle power supply to OFF mode.
- › AVH has been in operation for more than 3 minutes.

NOTICE

When the auto vehicle hold function is operational, if the system detects that the vehicle is rolling, it will actively increase the brake pressure to keep the vehicle stationary. You will hear sound and feel vibration when this happens.

CAUTION

When in an automatic car wash or being towed, please turn off the auto vehicle hold function.

Automatic departure function

When the parking brake is applied, and the driver fastens their seat belt and presses on the accelerator pedal, the system will detect the driver's intention to depart and automatically release the parking brake.

On a slope, to prevent the vehicle rolling back, greater traction is required to achieve this.

Vehicle equipment

Please note that this manual describes all standard equipment, country-specific equipment and special equipment for this series. Therefore, some equipment or functions described in this manual may not be installed in your vehicle or only available in certain markets. To learn more about specific configurations, please refer to sales documents or consult the dealer where you purchased the vehicle.

Gears

Park (P)

Park is used when the vehicle is parked. In Park the vehicle is mechanically locked to prevent it moving.

Reverse (R)

Reverse is used to reverse.

Neutral (N)

It is used when starting or stopping the vehicle, take care to ensure the vehicle does not roll away.

! WARNING

- › When temporarily stopping the vehicle in Neutral, please be sure to apply the parking brake or press the brake pedal, otherwise the vehicle might roll off and result in an accident.
- › Do not coast in Neutral, as it could result in an accident.

Automatic mode (D)

When driving normally, use Drive.

Changing gear

Once the vehicle starts, you can change gears normally. You should always press on the brake pedal before driving off, otherwise the vehicle will move on its own when placed in drive.

i NOTICE

- › When the vehicle speed is lower than 2 km/h, the driver's seat belt is unbuckled and the driver's door is opened, the vehicle automatically switches to Park.
- › After the vehicle is turned off, it automatically switches to Park.
- › After changing gear, verify that the vehicle is in the correct gear.



2739875A9A31

Ⓐ Park button

Ⓑ Gear change twist knob

Switching to Park

When the vehicle is stationary, press the Park button.

Switching to Drive, Reverse and Neutral

The gear change twist knob can be turned in a clockwise or anticlockwise direction, to select different gears as required.



4181373FCA37

- › When the vehicle is stationary and you are changing from Park to Neutral, Reverse or Drive, you must press on the brake pedal and then rotate the knob.
- › When the vehicle is stationary and you are changing from Neutral to Reverse or Drive, you must press on the brake pedal and then rotate the knob.
- › If you want to put the vehicle in Neutral, you just rotate the knob.

i NOTICE

The selected gear will be displayed on the gear change screen and in the centre of the instruments panel. After changing gear, make sure that you have selected the gear you want.

Creep function

After starting the vehicle (the **READY** light is illuminated), selecting Drive, and

releasing the parking brake and the brake pedal, the vehicle will creep slowly forwards without pressing the accelerator.

i NOTICE

Due to different model configurations, in some models it is necessary to turn on the personalised driving mode through the media screen and then activate the creep function.

Driving off

Normal driving off

1. Fasten your seat belt and confirm that you have applied the parking brake.
2. Press the brake pedal and start the vehicle (the **READY** will light up).
3. Switch the gear to the drive gear.
4. Release the brake pedal and then gently press the accelerator pedal to accelerate.

i NOTICE

When the vehicle drives off, the automatic departure function will automatically release the parking brake.

Launch

1. Fasten your seat belt and confirm that you have applied the parking brake and start the vehicle (the **READY** light is illuminated).

Go to **【Power Assistant】** → **【Power Flow】** on the multimedia screen to confirm that the battery power is not below 40%, then switch the driving mode to sport and confirm that the ESC function is turned off.

2. The left foot steps down the brake pedal to change the gear position to Drive. At the same time, the right foot presses down the accelerator pedal fully and the instrument panel indicates "Launch control activated".
3. Release the brake pedal and the vehicle starts in launch until driving off is complete.

WARNING

- › Be sure to drive carefully and within the speed limit.
- › The Launch can only be used in locations with no cross vehicle flow or pedestrian. It is the responsibility of the driver to ensure that his driving style and acceleration do not endanger or interfere with the safety of others on the road.
- › Avoid using this function on wet and slippery roads. Doing so could cause you to lose control of the vehicle and lead to an accident.

CAUTION

If braking is maintained for 3 seconds after Launch is activated, the vehicle exits the Launch function and enters

timeout protection to protect the motor system. Once the timeout state is entered, you need to release the accelerator pedal to exit the timeout state to enter Launch again.

NOTICE

The power battery temperature may prevent the normal activation of Launch.

Park

1. After releasing the accelerator pedal, press on the brake pedal.
2. Once the vehicle has stopped, switch to Park.
3. Apply the parking brake.

NOTICE

When the driver's seat belt is released and the driver's door is opened, the vehicle will automatically apply the parking brake.

4. Release the brake pedal.

CAUTION

- › When a vehicle needs to be temporarily stopped on a slope, the brake pedal must be pressed or the parking brake must be applied. Do not use the accelerator pedal or creep function to prevent the vehicle rolling back.
- › When the vehicle is parked on a slope, if necessary use wheel blocks

so as to prevent the vehicle from rolling downhill.

Driving mode

Vehicle equipment

Please note that this manual describes all standard equipment, country-specific equipment and special equipment for this series. Therefore, some equipment or functions described in this manual may not be installed in your vehicle or only available in certain markets. To learn more about specific configurations, please refer to sales documents or consult the dealer where you purchased the vehicle.

Switching modes



BC4A0A7FCDA4

Select AUTO, normal mode, ECO mode or sport mode by pressing the button.

AUTO

Automatically switches to normal, ECO or sport mode depending on the driving style of the driver, the status of the vehicle and the road conditions.

Normal mode

The best driving mode based on driving conditions, vehicle power and economy.

ECO mode

The best mode for saving energy with energy consumption and comfort as the primary objectives. Suitable for driving at medium to slow speeds.

When selecting ECO mode, use the multimedia screen and the **【Vehicle Settings】** → **【Driving】** page to switch the A/C automatic limit function on or off.

Sport mode

Strong responsiveness for faster driving and overtaking other vehicles. Increases vehicle dynamics and offers an enhanced driving experience.

i NOTICE

Go to **【Vehicle Settings】** → **【Lighting】** → **【Sport Mode Lighting】** on the multimedia display to set the vehicle alert status when car search is triggered.

Personalised driving mode

Personalised driving mode can be set in **【Vehicle Settings】** → **【Driving】** on the multimedia screen. When personalised driving mode is on, you can customise the following options.

- › Energy recovery level
Sets the energy recovery level (%).
- › Speed limit adjustment
Sets the maximum speed for the vehicle.
- › Accelerator pedal sensitivity

Sets accelerator pedal sensitivity.

› Creep function

Turns the creep function on or off.

When this function is on the vehicle has been started (the **READY** light is illuminated), switch into Drive gear and release the hand brake and the brake pedal. The vehicle will slowly crawl forward without needing pressure on the accelerator pedal.

i NOTICE

Due to different model configurations, some models may not be equipped with personalized driving modes. For specifics, refer to the actual vehicle.

ECO+ mode

ECO+ mode (super ECO mode) can reduce unnecessary power consumption and increase vehicle range.

ECO+ mode can be turned on or off in **【Vehicle Settings】** → **【Driving】** on the multimedia screen.

i NOTICE

- › This mode is unavailable if the vehicle is moving at a speed greater than 60 km/h.
- › Vehicle speed is limited to 90 km/h in super ECO mode.

Single pedal mode

When the vehicle is stationary and horizontal, single pedal mode can be turned on and off in **【Vehicle Settings】** →

【Driving】 on the multimedia screen.

i NOTICE

- › We recommend that you do not turn single pedal mode on or off while driving.
- › For average driving, use of gentle acceleration and deceleration can help to improve vehicle range.

While in single pedal driving mode, the driver need only press, release or completely take their foot off the accelerator pedal to accelerate, maintain the current speed, slow down or stop. This mode is suitable for all kinds of normal driving. It is flexible, simple, and can significantly improve range.

! WARNING

- › The deceleration produced using single pedal driving mode cannot completely replace conventional braking. You should be ready to use the brake pedal in an emergency.
- › Once the vehicle has stopped in single pedal driving mode, the driver should not get out of the vehicle without completing other actions.
- › Do not use single pedal driving mode when parking the vehicle. When parking for long periods, place in Neutral and apply the parking brake.
- › We do not recommend the use of single pedal mode when the road is

icy or wet.

Usage

When single pedal driving mode is on and the vehicle is in Drive, accelerating, maintaining speed, slowing down and stopping is achieved by pressing, releasing or completely taking your foot off the accelerator pedal.

Single pedal driving mode may turn off or not function in the following situations:

- › When power battery charge is too high or too low.
- › When the temperature of the power battery is too high or too low.
- › When the temperature of the drive motor is too high.
- › When ESC is activated.
- › When you switch to another driving mode.

After the vehicle is stopped using single pedal driving mode, the following actions will put the vehicle into the creep state:

- › Putting the vehicle in Reverse.
- › Turning off single pedal driving mode.
- › Exiting Drive then going back in to Drive.

CAUTION

- › Single pedal driving mode uses energy recovery to slow and stop the vehicle. The vehicle will stop on most road surfaces. However, deceleration

may be affected by the gradient of the road and vehicle load. The driver should always be ready to brake.

- › When the power battery charge is high and single pedal driving mode is on, the instruments panel will show “High battery charge. Single pedal function limited.”. Vehicle deceleration will also be affected, so the driver should always be ready to brake.
- › When the gradient is too steep or the vehicle has a fault, promptly press on the brake pedal to prevent the vehicle from rolling forwards/back.

NOTICE

When the vehicle is stopped using single pedal driving mode, EPB is automatically applied after a few seconds.

Vehicle equipment

Please note that this manual describes all standard equipment, country-specific equipment and special equipment for this series. Therefore, some equipment or functions described in this manual may not be installed in your vehicle or only available in certain markets. To learn more about specific configurations, please refer to sales documents or consult the dealer where you purchased the vehicle.

Usage

Acoustic vehicle alerts can be set in **【System Settings】** → **【Sound】** → **【Sound Effects】** → **【Pedestrian Warning Sound】** on the multimedia screen.

Each time the vehicle starts moving (READY or indicates) the acoustic vehicle alert system will start automatically.

When the forward speed is no higher than 30 km/h or if the vehicle is driven in reverse, the system will emit audible acoustic alerts.

WARNING

You should not over-rely on the acoustic vehicle alert system. Under some circumstances, pedestrians may not hear the alerts and could fail to notice a vehicle is approaching, which could result in an accident, injury or even death.

Power assisted steering mode

Vehicle equipment

Please note that this manual describes all standard equipment, country-specific equipment and special equipment for this series. Therefore, some equipment or functions described in this manual may not be installed in your vehicle or only available in certain markets. To learn more about specific configurations, please refer to sales documents or consult the dealer where you purchased the vehicle.

Switching modes

After switching on the power, the assisted steering modes, including light, comfort, and sport can be adjusted in **【Vehicle Settings】** → **【Frequently Used】** or **【Vehicle Settings】** → **【Driving】** on the multimedia screen.

In cars with linked switching, when you switch driving modes, the power assisted steering mode also switches:

| Driving mode | Assisted steering modes |
|-------------------|-------------------------|
| ECO mode | Light |
| Normal mode | Comfort |
| Sport mode | Sport |
| AUTO mode | Comfort |
| Personalised mode | Comfort |
| ECO+ mode | Light |
| Single pedal mode | Comfort |

i NOTICE

When switching assisted steering

modes, the following conditions must be met:

- › The power assisted steering system is working normally.
- › The vehicle speed is below 120 km/h.
- › No significant turning is occurring.

Comfort

Suitable for normal driving habits

Sport

Reduces steering assistance and increases steering wheel resistance, recommended for use at high speeds, and in snow and rain.

Light

Increases steering assistance so that steering is easy, suited to urban driving and stop-and-go traffic.

Vehicle equipment

Please note that this manual describes all standard equipment, country-specific equipment and special equipment for this series. Therefore, some equipment or functions described in this manual may not be installed in your vehicle or only available in certain markets. To learn more about specific configurations, please refer to sales documents or consult the dealer where you purchased the vehicle.

Safety notice

WARNING

- › The park assist system is intended only as a helpful tool and should not be used in place of the driver's own observations of the environment. The driver must always take responsibility for safe driving and remain alert to the vehicle's surroundings when parking or performing similar manoeuvres.
- › The park assist system has blind spots where it may not detect an obstacle. Therefore, ensure that there are no children or animals near the vehicle when parking or performing similar manoeuvres.

CAUTION

- › Ensure that the tailgate is completely closed when reversing.
- › Do not strike any camera or sensor.

- › Do not point a high-pressure water hose directly at a camera or sensor when washing the vehicle. This could result in a system failure or fire.
- › Do not use any abrasive or sharp object to clean a camera or sensor. Use a soft cloth or low-pressure water to clean the surface of the cameras and sensors.

NOTICE

Ultrasonic waves affect the park assist system's radar, so under the following conditions, it may fail to detect or detect an obstacle poorly, and this is not a system failure:

- › When an object is small or fine such as a wire mesh, fence, pillar or rope.
- › When the surface of an object does not reflect the detection signal, or a person is wearing clothing that does not reflect the signal.
- › When the obstacle is snow, a textile or a substance whose surface easily absorbs sound waves.
- › When the obstacle is an acute-angle reflector or a cone-shaped object.
- › When driving on grassy or bumpy roads.
- › When reversing on a slope.
- › When the surroundings have ultrasonic interference at the same frequency, such as from metal or high-pressure gas emission or when a vehicle horn is sounding directly at the

sensor.

- › When the number plate is bent, tilted or a large decorative number plate frame is installed.
- › When the sensor's surface is covered.

To ensure that the system functions properly, make sure that the sensor is clean and does not have anything covering it, like snow or ice.

Parking settings

The relevant functions of the parking assist system can be set in **【Vehicle Settings】** → **【Parking】** on the multimedia screen. Please refer to your vehicle for the actual settings procedure.

- › **【Front Sensor Auto ON】**

Switches automatic triggering of the front sensors on or off.

After the function is switched on, when the vehicle speed is less than 10 km/h and an obstruction is detected within range, the front radar and imaging system are switched on automatically. If the distance to the obstruction does not change within a few seconds, the obstruction is far away, or the parking brake is applied, the system will automatically switch off.

- › **【Low Speed AEB】**

The low speed emergency braking function can be switched on or off. After the function is switched on,

when the vehicle is driving slowly,  the low-speed emergency braking function light on the imaging screen lights up green, indicating that the function is normal and operational. At this time, if an obstruction is detected and it is judged that there is a risk of collision, the system automatically performs emergency braking to reduce the risk of collision, and the light turns red.

CAUTION

- › This function is intended only as a helpful tool and cannot be guaranteed to detect all obstructions under all circumstances.
- › In complex road situations (such as roads crossing fields, narrow lanes and so on), switch off the low-speed emergency braking function. Otherwise the system may perform unnecessary braking.
- › **【Side Safety Distance Warning】**
You can switch the side safety distance warning function on or off.
After the function is switched on, when the sensors on the left or right side of the body detect an obstruction, the system will remind the driver to park carefully with images and sound alerts.
- › **【Automatic Blind Spot Camera】**
You can switch the automatic blind spot camera function on or off.

When the function is switched on and the vehicle is in Drive, the panoramic view is automatically turned on when you activate the indicators or the steering wheel is turned to a certain angle. When the steering wheel returns to its original position, the indicator is cancelled or the vehicle reaches a set speed, the panoramic view is automatically turned off.

› **【Disable Surround View】**

The speed at which the panoramic view is turned off can be set.

When the speed of the vehicle exceeds a set value, the panoramic view is turned off automatically.

› **【Enable Surround View】** : Switches to the panoramic view screen.

Panoramic view

System overview

The panoramic view system (also called surround view) captures the vehicle surroundings through four cameras and transmits the image signal to the screen, ensuring safety by making control of the vehicle easy, thus preventing collisions.

Usage

- › When in Reverse, the panoramic view is turned on automatically.
- › When in Park, the panoramic view is turned off automatically.
- › When the speed of the vehicle exceeds a set value, the panoramic view is turned off automatically.

Screen overview

NOTICE

The layout of the panoramic view screen may not be the same for all models. Use your actual vehicle for reference.

 : Touch this button to exit the panoramic view.

 : Touch this button to turn on the intelligent integrated parking system. (▷ Page 115)

 : Touch this button to turn on the track-back reverse function. (▷ Page 117)

 : Touch this button to toggle between 2D and 3D view modes.

 : Touch this button to access the auxiliary functions of the panoramic view system.

 : In 3D view mode, you can switch the transparent chassis function on or off.

When the transparent chassis function is on, the imaging screen gradually displays an image of the road beneath the vehicle as the vehicle progresses.

 : Touch this button to toggle the viewing angle of the image between the default viewing angle, the wheel viewing angle, and the vehicle path viewing angle.

 : Touch this button to switch off the panoramic view system auxiliary functions.

Switching views

› Automatic view switching

When the D gear is engaged, the view automatically switches to the front view; when the R gear is engaged, the view automatically switches to the rear view. In D gear, turning on left or right turn signal, the view will automatically switch to the front wheel view.

› Manual view switching

When the vehicle speed is below 10 km/h, you can manually switch views.

In 2D view mode, by touching the area around the vehicle on the panoramic image you can switch the view to the corresponding area.

In 3D view mode, touch the panoramic image and it displays multi-directional buttons. By touching different direction buttons, the imaging area displays the view corresponding to the button; by touching the button on the bonnet, you activate the transparent engine compartment function and the imaging screen will gradually display an image of the road below the engine compartment, as the vehicle progresses.

Anti-collision radar

System overview

The anti-collision radar installed is a type of radar sensor. When parking, the sensors detect whether there is an obstruction in front of or behind the vehicle and the distance to the obstruction, and

issue an audible alert to assist the driver's safety and help make parking easy.

Usage

- › The anti-collision radar and panoramic view system are switched on and off together.

Detection range and alarm method

| Sensor position | Detection range [m] |
|-----------------|---------------------|
| Front side | 0.6 |
| Front centre | 1.0 |
| Rear Side | 0.6 |
| Rear centre | 1.5 |

When the anti-collision radar is switched on, if the sensor detects an obstruction within range, it will sound an alarm.

As the distance between the vehicle and the obstruction shortens, the frequency of the warning sound will gradually increase, and when the vehicle is about to hit the obstruction, the warning will sound for longer. At this point in order to avoid a collision you must stop the vehicle.

i NOTICE

Due to different model configurations, some models are not equipped with the front radar. For specifics, refer to the actual vehicle.

Intelligent integrated parking system

System overview

The intelligent integrated parking system uses the panoramic view imaging system and the collision-avoidance radar system. The radar sensors and cameras detect obstacles surrounding the vehicle and parking space lines to identify where the vehicle should be parked. The system then automatically controls the vehicle's steering, shifting and braking. The driver needs only to follow the system indications to enter and exit the parking space.

When parking, if pedestrians, vehicles and other moving obstructions are detected and there is the risk of a collision, the system will automatically perform emergency braking and rapidly bring the vehicle to a stop; if a fixed obstruction is detected and there is the risk of a collision, the system will brake softly and stop the vehicle smoothly.

WARNING

The intelligent integrated parking system is meant to assist the driver. It cannot replace the driver's judgement of the conditions outside the vehicle. When parking, continuously pay attention to your surroundings and the warning messages from the parking system. To ensure safety, take control over the vehicle and other necessary

measures when unusual situations occur.

Usage

After starting the vehicle, touch the **【Intelligent Parking】** button on the 360 panoramic view imaging page to activate the intelligent integrated parking system.

With the system activated, you can park simply by following the prompts on the multimedia display.

CAUTION

To ensure safe parking, the driver needs to monitor the vehicle surroundings at all times and immediately take control of the vehicle if there is the risk of a collision.

NOTICE

- › You can select to leave a parking space only when the vehicle is stationary.
- › When looking for a parking space, make sure there is sufficient space (around 0.5-1.5 m) between you and adjacent vehicles or obstructions, if not, the system may not detect the parking space.

Precautions

The following conditions will interrupt intelligent parking. When the interruption ends, the process will continue.

- › Opening a door (including the boot lid).
- › Folding the side mirrors.
- › Unfastening the driver's seat belt.
- › If there is an obstruction in the approach to the parking space.
- › Interfering with the accelerator pedal.

The following may cause the vehicle to exit intelligent parking:

- › If when looking for a parking space the vehicle speed is over 30 km/h.
- › Interfering with the gear, the steering wheel or the parking brake.
- › If a time-out occurs due to interruption, if the interruption is too long, if the parking manoeuvre is too slow, or if the total parking time is too long.
- › Touching the intelligent parking button.
- › When exiting a parking space, the system determines that the vehicle cannot exit in any direction or determines that the path is clear and therefore there is no need to use the intelligent parking function.
- › If the vehicle is on a steep incline.

The system cannot be applied to all parking scenarios. In some unusual cases the system may not function as expected. There are some examples below but these are not exhaustive:

- › The parking space cannot be identified due to environmental factors, such as dirty parking space markings,

markings covered by large amounts of rubbish, weeds, soil or other materials, poor light or strong reflections on parking spaces.

- › Uneven surfaces make it impossible to detect the parking space markings.
- › There are potholes in the surface of the parking space markings.
- › There are vehicles in front of or behind the empty parking space that are too close or are occupying part of the parking space.
- › There are pedestrians or other objects in the parking space.
- › While the vehicle is stationary, there are pedestrians or other obstructions near the camera.
- › There are old, residual parking lines in the current parking space.
- › The parking space is located on a corner or bend.
- › The vehicle's tyres are severely worn or unrecognised tyres (such as a non-full-size spare tyre) have been fitted.
- › Using this function on uneven surfaces (i.e. weeds or gravelled roads, etc.) could lead to a system identification error which might lead to unnecessary braking.
- › External sounds interfere with the system, leading to a sensor identification error, leading to erroneous reporting of non-existent obstructions.
- › Sensors are dirty or covered.

- › There is heavy fog, rain or snow.

Do not use intelligent parking in these situations:

- › If you have fitted snow chains or a spare tyre.
- › If the vehicle is carrying a load that extends beyond the confines of the vehicle.
- › If you have installed a towing device.
- › If the vehicle is on a steep incline.
- › If there are large potholes.

Track-back reverse

System overview

When travelling in Drive at a speed of 30 km/h or less, the system records the vehicle track over the last 50 metres in real-time; when the track-back reverse function is turned on, the system controls the steering wheel, the brakes and the speed to automatically reverse the vehicle according to the track recorded.

While reversing, if pedestrians, vehicles or other non-fixed obstructions are detected and there is a risk of a collision, the system automatically performs emergency braking, and rapidly brings the vehicle to a stop.

i NOTICE

Because of mechanical deviation, tyre pressures and other factors that affect the accuracy of the system control, the reverse vehicle track can deviate to a certain extent, it is not guaranteed to

follow the original track exactly.

⚠ WARNING

Track-back reverse is intended only as a helpful tool, and cannot replace the driver's appreciation of the situation. When reversing the driver must observe their surroundings and take note of reversing alerts; if something unexpected happens they should take control to ensure safety.

Usage

After starting the vehicle, touch the **【Track-back Reverse】** button on the panoramic view screen to activate the track-back reverse function.

When the track-back reverse function is active, automatic reversing can be completed via the prompts on the multimedia screen.

⚠ CAUTION

To ensure safe parking, the driver needs to monitor the vehicle surroundings at all times and immediately take control of the vehicle if there is the risk of a collision.

Precautions

The system will stop and clear the recorded track under the following circumstances:

- › If the vehicle speed is over 30 km/h.
- › If the vehicle shuts down abnormally.

- › If the steering wheel is turned excessively (about 450°).
- › If the vehicle diverges from the recorded track by more than one metre.

While reversing, the following situations might cause the track-back reverse function to be interrupted or stop working:

- › Touching the track-back reverse button.
- › Interfering with the gear, the steering wheel, the parking brake, or the accelerator pedal.
- › Unfastening the driver's seat belt.
- › Opening a door (including the boot lid).
- › Folding the side mirrors.
- › If the system detects that the vehicle is unable to continue.
- › If an obstruction is detected on the route.

i NOTICE

Restart the track-back reverse function after a non-system fault or exit and the system will finish reversing following the remaining track.

Vehicle equipment

Please note that this manual describes all standard equipment, country-specific equipment and special equipment for this series. Therefore, some equipment or functions described in this manual may not be installed in your vehicle or only available in certain markets. To learn more about specific configurations, please refer to sales documents or consult the dealer where you purchased the vehicle.

System overview

The tyre pressure monitoring system (TPMS) can monitor tyre pressures and temperatures in real-time, and give an immediate warning if a tyre develops a problem; it will warn the driver to take action, thus preventing an accident.



CAUTION

- › If a replacement tyre is not a genuine spare part, it may affect the normal operation of the TPMS.
- › TPMS may not work properly when snow chains are fitted or when a wheel is covered.
- › TPMS may not work properly due to wireless interference.
- › When tyres have been replaced or switched round, after driving continuously for about nine minutes at a speed of more than 30 km/h, the tyre pressure monitoring system will automatically identify tyre pressure,

tyre temperature and position. If the tyre pressure and temperature do not display correctly after nine minutes, please contact an authorised service centre to have the TPMS reset.

- › TPMS is not a substitute for normal maintenance. Even if TPMS does not issue a warning, tyres and tyre pressures should be checked regularly to ensure they are normal.
- › Tyre pressures can be affected by factors such as heat generated by driving, the environment and driving time. Generally speaking, tyre pressure fluctuations of around 30 kPa are normal.

Monitoring function

On the steering wheel, press the  home button, and the instruments panel will switch to the driving data page. On the driving data page, press the  up or  down selector buttons on the driving data page to switch to the tyre pressure monitoring page to display the pressure and temperature of all four tyres in real-time.

If a tyre's pressure is too low or a tyre is too hot, the abnormal tyre icon on the tyre pressure monitoring page will flash in red.

Warnings

If the tyre pressure is low or the tyre's temperature is too high, the instrument

panel will provide the following warning:

- › The information centre displays an alarm window, the affected tyre displays in red, and an audible alarm sounds.
- › On the instrument panel, the tyre pressure monitoring system warning light (⚠) illuminates.

If there is a warning about one of the tyres, avoid sharp steering or harsh braking. Reduce your speed, pull over at a safe location, park the vehicle as soon as possible, and contact an authorised service centre for assistance.

Vehicle equipment

Please note that this manual describes all standard equipment, country-specific equipment and special equipment for this series. Therefore, some equipment or functions described in this manual may not be installed in your vehicle or only available in certain markets. To learn more about specific configurations, please refer to sales documents or consult the dealer where you purchased the vehicle.

Intelligent monitoring system

Driver monitoring system

Go to **【Vehicle Settings】** → **【In-car】** → **【In-Cabin Monitoring】** → **【Driver Monitoring System】** on the multimedia display to turn this function on or off. After switching on the function, you can customise the following settings:

- › **【Distraction Monitoring】** : When this function is switched on and whilst driving, when the system recognizes that the driver is distracted, the system will issue a voice alert. The instrument panel will also display an alert message. If the driver continues to drive while distracted, the system will change the voice alert automatically depending on how distracted the driver is.

CAUTION

Turning on an indicator or turning the

steering wheel a certain degree will restrict the distraction monitoring function and stop it from issuing any further instructions.

- › **【Fatigue Monitoring】** : When this function is on and whilst driving, the system will issue an audible prompt or a voice alert when it detects that the driver is fatigued, depending on how fatigued the driver is. The instrument panel will also display the alert message. If the system issues a voice alert, it means the driver's fatigue is significantly affecting driving safety. Take the system's suggestion or stop at a safe place to rest as soon as possible.
- › **【Dangerous Behaviour Monitoring】** : When this function is on and whilst driving, the system will issue a voice alert when it detects dangerous driver behaviour.

WARNING

The driver monitoring system is intended only to assist the driver. The driver is responsible for the safety of the vehicle under all circumstances and should never drive when fatigued or distracted. The driver must always drive carefully and attentively.

CAUTION

- › Check and confirm that the camera is clean and unobstructed to ensure that the system will work properly.

- › Do not clean the camera with anything abrasive or sharp.
- › Do not strike or bang the camera.

Vital signs monitoring system

Go to **【Vehicle Settings】** → **【In-Car】** → **【In-Cabin Monitoring】** on the multimedia display to customise the following settings for the vital signs monitoring function.

- › **【VMDR Biometric Identification】** : temporarily turns vital signs monitoring on or off.(▷ Page 202)

i NOTICE

Every time you switch the power mode to ON, vital signs monitoring is turned on by default.

- › **【Delayed Shutdown】** : turns the alarm delay function on or off. When on, vital signs monitoring will delay the alarm by 10 minutes.

Vehicle equipment

Please note that this manual describes all standard equipment, country-specific equipment and special equipment for this series. Therefore, some equipment or functions described in this manual may not be installed in your vehicle or only available in certain markets. To learn more about specific configurations, please refer to sales documents or consult the dealer where you purchased the vehicle.

System overview

When driving on a straight motorway in free flowing traffic, the cruise control assist system allows you to maintain a set vehicle speed without using the accelerator pedal. When the system detects that the speed of the vehicle in front is less than the cruise speed set in this vehicle, it will follow the vehicle in front at a safe distance.

Vehicles fitted with intelligent cruise assist can keep the vehicle between the lane markings while in cruise mode.

WARNING

- › The cruise control assist system is intended only as a helpful tool. It cannot replace the driver's judgment of the road and traffic conditions, nor can it completely replace control by the driver. Under all circumstances the driver is responsible for the safety of the vehicle and they must

always concentrate and drive with caution.

- › When not using the cruise control assist system please turn it off to avoid it being activated mistakenly.
- › Improper use of the cruise control assist system could possibly lead to a collision.
- › The cruise control assist system should be used only when driving in good weather and on unobstructed roads.
- › The cruise control assist system is not recommended for use in urban areas, on winding or narrow roads, wet or slippery surfaces, in heavy rain, or in other inclement weather conditions.
- › The use of the cruise control assist system is not recommended when driving in hilly terrain, mainly for the following reasons:

When driving uphill or downhill the cruise control assist system may not be able to maintain the set speed.

After the vehicle in front reaches the top or bottom of a hill, the cruise control assist system may not be able to detect it, resulting in sudden acceleration or late braking.

Usage

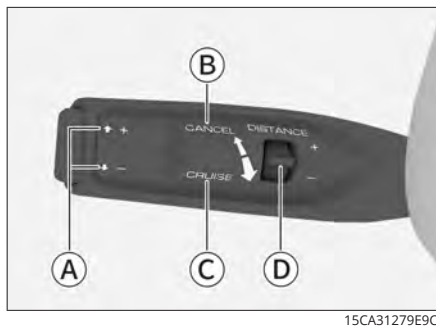

- (A) Vehicle speed adjustment
- (B) Cancel cruise
- (C) Activate cruise
- (D) Vehicle distance setting adjustment

Activate cruise

While driving, pulling the control lever towards the steering wheel to the **【CRUISE】** position and releasing it activates cruise assist. The minimum vehicle speed that cruise assist can be set to is 30 km/h.

Pull once, and adaptive cruise will be turned on and will show as such on the instruments panel

Pull twice and the intelligent cruise function will be turned on and will show as such on the instruments panel

i NOTICE

When the adaptive cruise function is on, the following basic conditions must be met before the cruising speed of the vehicle can be set:

- › All doors are completely closed.

- › The driver is already wearing their seat belt.
- › The vehicle has been started and is in Drive.
- › ESC is in the ON state.
- › The parking brake is not applied.
- › The vehicle speed is less than 150 km/h.
- › The vehicle driving mode is normal, ECO or sport mode.

When the intelligent cruise function is on, the following basic conditions must be met before the cruising speed of the vehicle can be set:

- › All doors are completely closed.
- › The driver is already wearing their seat belt.
- › The vehicle has been started and is in Drive.
- › ESC is in the ON state.
- › The parking brake is not applied.
- › The vehicle speed is less than 150 km/h.
- › The system has detected lane markings.
- › If the vehicle speed is lower than 60 km/h and there are no lane markings, a moving target must be detected.
- › The vehicle driving mode is set to normal, ECO or sport mode.

Cruising speed adjustment

Pull the control lever up or down to the

【+】 or 【-】 position and release, allowing speed to be increased or decreased by small amounts.

If you pull the control lever up or down to the 【+】 or 【-】 position and hold it there, the speed will continue to increase or decrease, then once you have reached the desired speed, all you need do is release the control lever.

i NOTICE

Only when the road ahead is clear will the vehicle accelerate to the speed set. Otherwise, it will follow the vehicle ahead, maintaining the vehicle distance set.

Cancel cruise

There are two ways to cancel cruise:

- › Press the brake pedal.
- › Push the control lever away from the steering wheel to the 【CANCEL】 position and release.

If you want to resume cruise, pull the control lever towards the steering wheel to the 【CRUISE】 position and release.

Adjust the vehicle distance setting

Pull the vehicle distance setting adjustment lever to adjust the vehicle distance setting.

Each distance setting is speed-dependent and not a fixed number of metres.

i NOTICE

- › Setting a lower vehicle distance

setting could result in the reaction time being too short if an accident occurs, and it is your responsibility to adjust the vehicle distance setting to a safe value.

- › When you are driving on a wet and slippery road surface you should choose a larger vehicle distance setting than when you are driving on a dry road surface.

i NOTICE

If the following situations arise, the vehicle will automatically exit the cruise function:

- › When the speed of the vehicle exceeds 150 km/h.
- › Cruise has been cancelled for more than 5 minutes.
- › If you have been pressing on the accelerator pedal to accelerate for more than 15 minutes.
- › If the vehicle is in Neutral, Reverse or Park.
- › If the driver's seat belt is released.
- › If the driver's door is opened.
- › If the parking brake is applied.
- › If the ABS system is activated.
- › If the hill descent control system is activated.
- › If the electronic stability control system is activated/turned off.
- › If the vehicle rolls backwards.
- › If the brake disks overheat.

- › If the vehicle is turned off.
- › If vehicle driving mode is not set to normal, ECO or sport mode.

Traffic jam assist

This function allows your car to follow another vehicle in stop-and-go traffic.

In traffic jams, this function will slow your car down or even bring it to a standstill in line with the vehicle in front.

Also:

- › If the vehicle in front starts moving forward again within 3 seconds, your car will follow it automatically.
- › If the vehicle in front stops for longer (for between three seconds and three minutes), press the resume speed setting/accelerator button or press lightly on the accelerator pedal to re-start the system.
- › • If the car in front stops for longer than three minutes, your parking brake will automatically be applied.
- › • If the driver opens the door or takes off their seat belt, your parking brake will automatically be applied.

i NOTICE

If the cruise control speed set is cancelled or the cruise control assist system is switched off, this function will be turned off at the same time.

Cornering assist

After turning on cruise control assist, the

cornering assist system will slow the vehicle down if it detects that the speed of vehicle entering the curve is too high.

⚠ WARNING

- › When entering, completing or driving through a curve, the system may not be able to detect vehicles ahead in your lane promptly. This could cause late braking. The driver must be alert and ready to take control over the vehicle at all times.
- › When driving through a curve, the system may mistakenly detect vehicles in other lanes, causing unnecessary braking.
- › Driving on a road with sharp turns (such as switchbacks), if the vehicle ahead moves out of the detection range of the sensor, the vehicle may accelerate suddenly. The driver must be alert and ready to take control over the vehicle at all times.

Lane centring assist while cruising

Only the smart cruise mode has this function. When the system is working and the sensor detects the lane boundary or a moving vehicle ahead, the system helps the driver to keep the vehicle centred between the lane markings.

i NOTICE

- › Adaptive cruise control does not have this function.

- › If the cruising speed is cancelled, this function is cancelled too.

CAUTION

In some cases when cruising, lane centring assist may not work correctly or not work at all. The following are examples:

- › When cruising at or above 60 km/h and there are no lane markings, or the lane markings on both sides are unclear, non-standard or obstructed.
- › When cruising below 60 km/h and there are no lane markings, or the lane markings on both sides are unclear, non-standard or obstructed and there is no vehicle driving directly ahead.
- › When material on the road surface is affecting the detection of lane markings (such as water, gaps, ruts, text signs, bumps or potholes).
- › When visibility is low (such as in rain, snow, smog or at night).
- › When the vehicle is in strong crosswinds.
- › When lanes merge or divide.
- › When a strong light shines on the camera, or the light intensity abruptly changes.
- › When the windscreen around the camera is dirty, iced up, damaged or obscured.
- › When cornering quickly or driving on

a narrow road.

- › When the vehicle is too close to the vehicle in front, cutting off the camera's view.

Function limits

The cruise control assist system may not apply the brakes in the following situations:

- › If another vehicle suddenly cuts in front of your vehicle.
- › If a vehicle ahead is moving slowly and your vehicle is moving faster than 60 km/h.
- › If there is an oncoming vehicle in the same lane.
- › If a vehicle or object crosses the lane ahead.
- › If a pedestrian, animal or small vehicle (such as a bicycle or motorcycle) appears.
- › If another vehicle in front of your vehicle slows down suddenly.
- › If water, snow or mud has splashed onto the sensor, impairing its ability to function.
- › If the front of the vehicle is raised due to the luggage space being overloaded.
- › When cornering or driving on a narrow road.

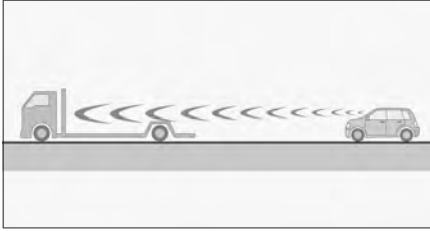

706CBE4C4337

- › If the rear of the vehicle ahead is small or is raised very high off the ground.
- › When use of the steering wheel or your position in your lane is erratic.

Sensors

The cruise control assist system uses a camera in the upper part of the wind-screen and a radar in the middle of the front bumper to identify lane boundaries and detect targets.

i NOTICE

When the instrument panel indicates that a system sensor's sensitivity is limited, make sure that the system is working as expected by checking whether the sensor and its surrounding area are clean and free of obstacles.

Vehicle equipment

Please note that this manual describes all standard equipment, country-specific equipment and special equipment for this series. Therefore, some equipment or functions described in this manual may not be installed in your vehicle or only available in certain markets. To learn more about specific configurations, please refer to sales documents or consult the dealer where you purchased the vehicle.

Usage

After starting the vehicle, use the multimedia screen to navigate to the **【Vehicle Settings】** → **【Intelligent Driving】** screen to turn the appropriate functions on or off.

Sensor

The intelligent driving assistance system identifies lane markers and detection targets using the following components.

› Camera.

The camera is located at the top of the windscreen.

› Sensors.

Sensors are located on both sides of the rear bumper.

i NOTICE

When the instruments display a warning that sensor detection is limited, check to make sure the camera and sensors and their surroundings are

clean and free of obstructions to ensure the system functions normally.

Forward assist system

The forward assist system identifies vehicles in your lane via a camera on the windscreen. When it detects that there is a collision risk ahead, it will emit a warning or implement a brake intervention to lessen the potential severity of any accident.

The relevant functions can be set in **【Vehicle Settings】** → **【Intelligent Driving】** → **【Front Assist】** on the multimedia screen.

⚠ WARNING

This system cannot be guaranteed to operate normally under all circumstances. Therefore, you should not drive a vehicle towards pedestrians, animals or vehicles for the purpose of testing this system. This could cause serious injury or death.

In complex driving conditions, the system may perform unnecessary braking. For example, near construction sites or railroad tracks, or when there is spray or water splashed up from the vehicle in front.

The system may not work properly or may not be effective in low visibility (such as rain, snow, haze or at night, etc.)

AEB activated

Can detect most vehicles which are stationary or moving in the same direction as you (i.e.: passenger vehicles, trucks, buses, etc.)

- › **【Off】** : The function is off.
- › **【Brak】** : Brake assist is on.

Brake assist

When the vehicle speed exceeds 30 km/h and the system detects a pedestrian or a vehicle which presents a risk of collision, it will emit a warning to remind the driver to drive safely. Warnings are divided into 2 grades: Audible warning (pre-warning) and a short braking warning (emergency warning).

In an emergency, if the driver does not respond by braking, the system will take over and apply emergency braking (limited braking), and the hazard lights will flash to warn the vehicle behind and reduce the risk of collision.

Crossing assist

Automated emergency braking functions can also partly respond to the potential risks that occur when an intersection turns.

When the vehicle speed is lower than 20 km/h and the vehicle is turning at a junction, if the system detects oncoming cars or pedestrians, and there is a risk of a collision, braking will occur.

The system can detect pedestrians and vehicles that are moving in the opposite

direction to your vehicle (i.e. passenger vehicles, trucks, buses, etc.). Poor lighting may affect the detection range. Turn on the headlamps when driving at night.

i NOTICE

- › At lower vehicle speeds, this function may slow the vehicle to a standstill, however it will not keep the vehicle stationary. At this time, the driver should actively apply the brakes.
- › When a vehicle cuts into the front of the self-vehicle at close range (especially a bus, cargo vehicle, etc.), the system may not be able to identify in time, resulting in the vehicle not braking in time.
- › When the vehicle rate is high, the system may not recognize the stationary target and hence will not make a braking response.
- › As the vehicle conducts automatic emergency braking, if the driver takes evasive action by operating the accelerator pedal, brake pedal or steering, the system may exit automatic emergency braking.

i NOTICE

- › Once the vehicle speed exceeds 65 km/h, and the system determines that the vehicle is too close to the vehicle ahead, the warning "Keep a Safe Distance" will appear on the instruments cluster.

- › If the cruise control assist system is operational, the safe distance warning function will be hidden.
- › Poor lighting may affect the detection range. Turn on the headlamps when driving at night.

About detected targets

i NOTICE

Depending on the different targets identified by the system, the system cannot always achieve the same performance level for different vehicles, pedestrians, settings or road states.

- › Cyclists must be adults riding a bicycle designed for adults.

The best effect is achieved only when the system detects a clear and unmistakable outline of a human body and a bicycle. This means that the system needs to clearly identify the contour information of the bicycle, and the head, arms, shoulders, and thighs of the rider in addition to normal riding behaviour.

- › The system can detect pedestrians if their is contrast with the background (i.e., if the colour of a pedestrian's clothes is in sharp contrast to the colour of the surrounding environment). If the contrast is low, pedestrians will be detected late or not at all, which means that warnings and braking may be delayed or not occur.

The best effect is achieved only when the system detects a clear and unmistakable outline of a human body. This means that the system needs to clearly identify the head, arms, shoulders, and thighs of pedestrians in addition to normal walking gait.

Front cross traffic alert/brake

When the vehicle is driving off from a road junction and going straight (for example, at a traffic light), the system will respond with an alarm or by braking if it detects a vehicle coming from the right or left and determines that there is a risk of a crash.

Front cross traffic alert (FTCA): When the vehicle is starting off at 0 to 10 km/h, if it detects there is a risk of a crash, it will issue an alert.

Front cross traffic brake (FCTB): When the vehicle is starting off at 0 to 5 km/h, if it detects there is a risk of a crash, it will apply braking.

The system is able to detect vehicles (for example, passenger cars, lorries and buses) approaching from the side at 10 to 60 km/h. Poor lighting may affect the detection range. Turn on the headlamps when driving at night.

Front collision warning sensitivity

There are three levels of sensitivity.

- › Low: Indicates the warning distance is shorter than the distance defined by the system.

- › Medium: Indicates the normal warning distance as defined by the system.
- › High: Indicates the warning distance is longer than the distance defined by the system.

Side and rear assist system

The side and rear assist system can detect vehicles behind you or in the adjacent lanes via the sensors on both sides of the rear bumper. If there is a risk of collision, the system will emit a warning to alert the driver.

The relevant functions can be turned on or off in **【Vehicle Settings】** → **【Intelligent Driving】** → **【Side and Rear Assist】** on the multimedia screen.

i NOTICE

- › Please keep both sides of the rear bumper clean. Do not stick anything to it, and do not let ice, snow, mud, or other foreign matter cover the sensors as this will affect correct operation.
- › Improper servicing or customisation of the vehicle may result in misalignment of the sensors which may adversely affect the normal operation of the side and rear assist system. Therefore, it is recommended that you go to an authorised service centre to maintain your vehicle.
- › When towing another vehicle, please

turn off the side and rear assist system.

Warning light

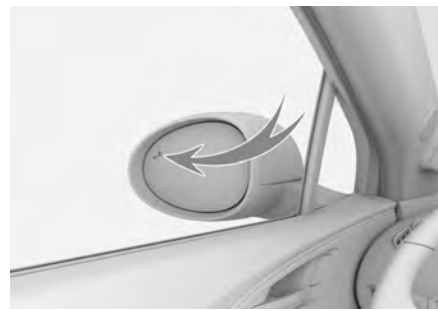

The warning lights are on the surface of the left and right side mirrors.

⚠ WARNING

Do not stick anything over the warning lights to avoid affecting the system warning function.

Lane change assist

When driving (if the vehicle speed exceeds 15 km/h), if the system detects a vehicle in the blind spot of the side mirrors, or a vehicle in a neighbouring lane is approaching, the warning light on the appropriate side will come on. If you activate the indicators on that side, the warning light flashes and there is an audible alarm to warn you that it is dangerous to continue to change lanes.

⚠ WARNING

In certain circumstances, the lane change assist function may not work

properly or may not be effective. For example:

- › With fast approaching or departing vehicles.
- › With smaller objects (pedestrians, bicycles, etc.).
- › With stationary objects (vehicles, pedestrians, etc.).
- › In heavy rain or snow.
- › On sharp bends, slopes, and with lanes that are very wide or very narrow.

Door open warning

Once the vehicle is stationary, if the system detects approaching vehicles or bicycles in neighbouring lanes, and there is a risk of collision if the door is opened, the warning light on the corresponding side will light up. If the occupant of the vehicle continues to open the door, the warning light will flash and an audible alarm sounds to alert you of the danger of continuing to open the door.

NOTICE

- › The door open warning function will only work normally in the following circumstances:
 - When the vehicle is on.
 - Within 2 minutes of pressing the vehicle power off switch.
- › When towing other vehicles, the door open warning function is not available.

WARNING

Under certain circumstances, the door open warning function may not work properly or may not be effective. For example:

- › With fast approaching or departing vehicles.
- › With smaller objects (pedestrians, etc.).
- › With stationary objects (vehicles, pedestrians, etc.).
- › In heavy rain or snow.
- › On sharp bends, slopes, and with lanes that are very wide or very narrow.

Rear collision warning

When the system detects that there is a fast approaching vehicle, bicycle, or other object that presents a collision risk, the hazard lights will flash fast, and the instruments panel will show a driver alert that the “vehicle behind is approaching too fast” accompanied by an audible warning that there is a risk of collision between your vehicle and the object that is approaching.

WARNING

In certain circumstances, the rear collision warning function may not work properly or may not be effective. For example:

- › If the vehicle behind is close to your vehicle and the relative velocity of

the two vehicles is too high or too low.

- › With smaller objects (pedestrians, etc.).
- › With stationary objects (vehicles, pedestrians, etc.).
- › In heavy rain or snow.
- › On sharp bends, slopes, and with lanes that are very wide or very narrow.

Reversing cross traffic warning

After turning on the reversing cross traffic warning function, if when reversing the system detects that there is a risk of collision with a vehicle moving in the blind spot of the side mirrors, it will emit an alarm to remind the driver to drive safely.

Reversing cross traffic braking

After the reversing cross traffic braking function is turned on, limited braking can be applied when there is a danger while reversing the vehicle, thereby reducing the risk of collision.

NOTICE

With the vehicle switched on, put it in Reverse, and the reversing cross traffic assist function will be active.

WARNING

In certain circumstances, the reversing cross traffic assist function may not work properly or may not be effective.

For example:

- › With fast approaching or departing vehicles.
- › With smaller objects (pedestrians, bicycles, etc.).
- › With stationary objects (vehicles, pedestrians, etc.).
- › In heavy rain or snow.
- › On sharp bends, slopes, and with lanes that are very wide or very narrow.

WARNING

In certain circumstances, the reversing cross traffic braking function may not work properly or may not be effective. For example:

- › When the current speed is too high or too low.
- › When the driver presses down hard on the accelerator pedal.
- › When the driver turns the steering wheel rapidly.

Lane assist system

The lane assist system is designed for driving on motorways and other roads in good conditions. Lane markings are recognised by the camera on the windscreen, and if the driver leaves the lane without being aware of it, it will alert the driver to get back in lane; certain functions even assist the driver to correct direction so as to lessen the potential severity of any accident.

The relevant functions can be turned on or off in **【Vehicle Settings】** → **【Intelligent Driving】** → **【Lane Assist】** on the multimedia screen.

WARNING

- › The lane assist system is intended only as a helpful tool. It cannot replace the driver's appreciation of the road and traffic conditions, nor can it completely replace control by the driver. Under all circumstances the driver is responsible for the safety of the vehicle and they must always concentrate and drive with caution.
- › The driver must always keep their hands on the steering wheel and be ready to take over the steering at any time. It is always the responsibility of the driver to keep the vehicle safely in lane.

CAUTION

The lane assist system works properly only when the lane markings are clearly visible. Under some circumstances it might not work properly or may not function. For example:

- › If the lane markings are not clear, are not standard or they are covered up, etc.
- › When there are objects on the road that obstruct the lane markings, (such as puddles, gaps, tyre marks, textual markings, pedestrian

crossings, unevenness or potholes, etc.)

- › If visibility is low (i.e. in rain, snow, haze, or at night, etc.)
- › If the vehicle is significantly affected by crosswinds.
- › When lanes merge or separate.
- › If bright light affects the camera or if lighting intensity changes suddenly.
- › If the glass on the windscreen around the camera is dirty, broken, or it is covered.
- › When driving round a sharp bend, along a narrow road, or on roads with a camber.
- › If you drive too close to the vehicle in front, obscuring the field of view of the camera.

NOTICE

If you indicate, deliberately steer and accelerate or brake before crossing a lane marking, the system will be unable to intervene. Under these circumstances the system assumes that you are actively driving the vehicle.

NOTICE

If the driver uses a very light touch on the steering wheel, the system may not detect that the driver is holding the steering wheel and the instruments cluster will emit a warning.

Lane assist function

After switching on the lane assist function you can select the mode of assistance.

- › Lane keeping assist: If the driver is unintentionally drifting out of lane, this function will assist the driver by correcting the steering to keep the vehicle in the lane. If the correction fails, it will emit a warning to remind the driver to drive safely.
- › Lane departure warning: If the driver is unintentionally drifting out of lane, a warning will be emitted to remind the driver to drive safely.

i NOTICE

Lane assist functions will work only when the speed is between 60-150 km/h.

After switching on the lane assist functions, the instruments cluster will show the lane markings.

- › Grey: Shows that the system has not detected the lane markings.
- › Green: Indicates that the system has detected the lane markings.
- › Red and flashing: Indicates a system warning, at this point the driver needs to make a steering adjustment to return to the lane.

i NOTICE

Lane centring assist will work only

when the system identifies the left and the right lane markings.

Emergency lane keep assist

If emergency lane keep assist is switched on, in an emergency the system will adjust the steering wheel more actively to reduce the risk of a collision. For example: This function will activate when the driver is unintentionally drifting out of lane or turns on the indicator to change lane, and there is the risk of a collision with an oncoming vehicle or a vehicle travelling in the same direction in the neighbouring lane, or changing the lane could cause the vehicle to hit the kerb or a pothole.

i NOTICE

The emergency lane keep assist function works only at speeds of 60-150 km/h.

⚠ WARNING

Under some circumstances the emergency lane keep assist function may not function. For example:

- › With smaller objects (motorcycles, bicycles, etc.)
- › With stationary objects.
- › If your vehicle is driving too close to the vehicle in front, and detection by the camera is obstructed.
- › If the vehicle behind is driving too close to your vehicle, and detection

by the sensor is obstructed.

Smart Dodge

After smart dodge is switched on and the smart cruise assist mode is switched on and working, and the system detects that the vehicle is about to overtake a large vehicle (such as a van, lorry or bus) in an adjacent lane, it will put more space between this vehicle and that large vehicle while overtaking. After overtaking the large vehicle, the vehicle will return to the centre of the current lane.

NOTICE

The smart dodge function will work only at speeds of 60-150 km/h.

CAUTION

The smart dodge function might not be triggered in the following circumstances:

- › If the system detects a large vehicle in the lane on one side, but there is a vehicle in the lane on the other side or a kerb on that side.
- › In bad weather, such as fog, rain or snow or at night.
- › If the vehicle is on a bend.

Alert Mode

There are three types of warning: vibration, sound, vibration & sound.

Detection Sensitivity

Detection intensity is divided into three levels: low, medium and high.

Smart cruise

The function is mainly used for assisting the driver to safely and easily control the motorway after the intelligent cruise function is started on the vehicle.

When Smart cruise mode works, the close function of intelligent cruise can be normal usage. Close to usage Smart cruise models are detailed in "cruise assistance systems". (▷ Page 124)

WARNING

The system can not cope with all the traffic, weather and roadway conditions, in the light wire conditions poor (such as: Night, cloudy), light wire sharp change (such as: The identification ability of the sensor under the status such as in and out of the tunnel will be limited, therefore, it can not replace the judgment of the driver on the road state. The driver is responsible for vehicle safety under all circumstances and must always drive with caution and observe applicable laws and road traffic rules.

Personalised driving mode can be set in **【Vehicle Settings】** → **【Intelligent Driving】** → **【Smart Cruise】** on the multimedia screen.

Lane change assist (LCA)

Once activated, if the driver turns on the indicator when motorway lane markings are clear and the circumstances permit changing lane, the system will plan and execute the lane change autonomously.

CAUTION

During the autonomous lane changing process, do not let go of the steering wheel. To ensure the safety of the vehicle, the system can only work when it detects that the driver is gripping the steering wheel.

CAUTION

When the system detects that the driver is distracted or tired, or the current operating environment does not support the system continuing to control the vehicle, the system will issue a warning to remind the driver to take over the vehicle. If the driver fails to take over the vehicle in time, the system will stop the vehicle safely in the current lane.

The safe stopping procedure is as follows: The system will brake the vehicle slowly, then turn on the hazard warning lights, switch to Park, apply the EPB, and automatically trigger an emergency rescue call. The rescue centre will then attempt to communicate with the driver.

Voice broadcast

The voice broadcast type is customisable.

- › Lite: Provides you with key voice alert messages.
- › Normal: Provides you with more detailed voice alert messages.

Traffic sign information

The traffic sign information function identifies the traffic signs using the camera on the front windscreen and displays them on the instruments cluster to assist the driver.

The relevant functions can be set in **【Vehicle Settings】** → **【Intelligent Driving】** → **【Traffic Sign】** on the multimedia screen.

Traffic Sign Recognition

Traffic signs are identified by a camera on the front windscreen and displayed on the instruments cluster to remind the driver.

Over-Speed Alarm

After recognising a speed limit sign, if the vehicle exceeds the speed limit the system will emit an alert to remind the driver to reduce speed to within an appropriate range as soon as possible.

Cruise Speed Limit

After the traffic sign recognition function is turned on, the cruise speed limit function can be activated.

When driving in cruise control, if the system identifies a speed limit sign of ≥ 30

km/h and the speed of the vehicle is higher than that indicated by the speed limit sign, the system will ask the driver whether or not to reduce speed to the current speed limit. After the driver confirms this, the system will assist the driver to reduce speed to within the speed limit.

Over-Speed Alarm Sensitivity

You can set when the sensitivity of the alert based on your own driving style.

- › When set to 0: When the vehicle speed reaches the speed limit, the alert sounds
- › When greater than 0: The alert only sounds once the vehicle exceeds the speed limit.
- › When less than 0: The alert sounds in advance of the vehicle reaching the speed limit.

WARNING

The traffic sign information function is only for warning drivers to pay attention to traffic signs, and is not suitable for all situations. It cannot replace the driver's judgment of the speed limit information on roads.

The driver is responsible for vehicle safety under all circumstances and must always drive with caution and observe applicable laws and road traffic rules.

CAUTION

The traffic sign information function works only in conditions where the speed limit signs are clearly visible. In certain circumstances it may not work properly or may not be effective. For example:

- › If a sign is faded.
- › If a sign is on a curve.
- › If a sign is not angled correctly.
- › If a sign is flapping or damaged.
- › If a sign is completely or partly obscured.
- › If a sign is completely or partly covered by frost, snow or dust etc.
- › If the sign is too far away, or if speed is too high.
- › If signs or speed reminders form part of the road surface.
- › If visibility is low (i.e. in rain, snow, haze, or at night, etc.)
- › If bright light affects the camera or if lighting intensity changes suddenly.
- › If the glass on the windscreen around the camera is dirty, broken, or something is covering it.
- › If you drive too close to the vehicle in front, obscuring the field of view of the camera.
- › If speed is too low.

NOTICE

- › The default unit for speed limit signs detected by the system will be km/h

or mph depending on the market or nation. Please refer to your vehicle for the actual situation.

- › If multiple speed limits are displayed on one sign, the system displays the highest speed limit value.
- › If multiple speed limit signs are juxtaposed, the maximum speed limit is displayed by the system. Please observe the actual speed limit of your current lane.
- › Speed signs may not be recognized while the vehicle is turning.

Vehicle equipment

Please note that this manual describes all standard equipment, country-specific equipment and special equipment for this series. Therefore, some equipment or functions described in this manual may not be installed in your vehicle or only available in certain markets. To learn more about specific configurations, please refer to sales documents or consult the dealer where you purchased the vehicle.

Safety notice

Safe driving

Do not take risks just because the vehicle is equipped with driving assist systems. Maintain a speed and driving style that is appropriate for the visibility, weather, road and traffic conditions.

Modifications

Any modification to the suspension or using tyres or wheels that do not comply with the equipment specifications will affect the driving assist systems and may result in a system failure.

Sounds and vibrations

- › Some driving assist system (such as the anti-lock braking system) may produce vibrations or sounds from the motor during operation. These do not indicate a failure.
- › When the vehicle is jump-started due to a flat 12V battery, the engine may

not run smoothly, and the anti-lock braking system or electronic stability control warning light may illuminate. These issues are caused by the low battery voltage but do not indicate that the anti-lock braking system or electronic stability control has failure.

Anti-lock braking system

During emergency braking or when braking on a slippery road, the anti-lock braking system (ABS) helps to maintain control of steering by preventing the wheels from locking.

CAUTION

Do not press the braking pedal lightly in multiple times during emergency braking. This will increase your stopping distance.

The ABS is not designed to reduce your stopping distance. In the following situations, your vehicle may need a longer stopping distance than one not equipped with an ABS. You must maintain a safe distance from the vehicle in front.

- › On muddy, rocky or snow-covered roads.
- › When using snow chains.
- › On bumpy roads.
- › On roads with potholes.

The ABS may not work effectively in the following situations:

- › When tyre grip exceeds the limit (e.g.

with excessively worn tyres on a snowy road).

- › Driving at high speeds on a wet road surface.

Electronic brake force distribution system

When the vehicle is braking, the electronic brake force distribution system (EBD) automatically adjusts the braking force distribution ratio of the front and rear axles to improve braking efficiency. The system also works with the ABS to improve braking stability, thereby keeping the vehicle stable.

Emergency brake assist

The emergency brake assist system is activated when the driver presses the brake pedal quickly. It increases the effectiveness of the brakes and reduces the vehicle's stopping distance.

Traction control system

When the vehicle starts off or accelerates on a slippery road, the traction control system (TCS) helps to maintain the driving force and to prevent the drive wheels from spinning.

Secondary collision mitigation system

The secondary collision mitigation system (SCM) automatically applies the vehicle brakes after an initial collision (airbags inflate) to slow or stop the vehicle, thereby reducing the probability of a

secondary collision and the severity of any injuries.

Hill hold control

When the driver releases the brake pedal to start driving while on a hill, the hill hold control system (HHC) maintains the braking force for about 2 seconds to keep the vehicle from rolling back.

WARNING

If the gradient is steeper than 30%, the vehicle may roll back when starting. Therefore, do not rely too much on this system. Be careful to drive safely.

Electric power steering

Electric power steering enhances driver safety by monitoring the vehicle speed and adjusting the power assist in real time to ensure that steering feels light when driving at low speeds and is stable at high speeds.

Electronic stability control

The Electronic stability control (ESC) helps reduce risk on slippery roads and, in certain driving situations, improves driving stability by braking individual wheels.

When the ESC is activated, the ESC indicator light  on the instruments cluster flashes. At this time, you need to drive carefully.

i NOTICE

Generally the ESC should always be on. Only in the following special circumstances should you turn off the system:

- › When driving with snow chains.
- › When driving in deep snow or on soft roads.
- › When the vehicle is stuck and needs to be freed.

Once the above circumstances are no longer a concern, you should immediately turn on ESC.

How to turn on/off

The ESC can be turned on or off in **【Vehicle Settings】** → **【Frequently Used】** or **【Vehicle Settings】** → **【Driving】** on the multimedia screen.

On the instruments cluster, the  ESC OFF indicator light lights up, indicating that the ESC has been turned off.

i NOTICE

The ESC will turn on automatically under the following circumstances:

- › Every time the vehicle is started.
- › When the vehicle speed exceeds 85 km/h.

Vehicle equipment

Please note that this manual describes all standard equipment, country-specific equipment and special equipment for this series. Therefore, some equipment or functions described in this manual may not be installed in your vehicle or only available in certain markets. To learn more about specific configurations, please refer to sales documents or consult the dealer where you purchased the vehicle.

Overview



D8360A122A21

- A Speedometer
- B Driving mode information
- C Gear indicator
- D Personalised information
- E Battery level indicator
- F Intelligent driving information

i NOTICE

The data in the image is just an example and may differ from that of the actual vehicle.

Speedometer

Displays the current driving speed.

Personalised information

The type of information displayed here can be set as needed.

Battery level indicator

Displays the approximate charge remaining in the power battery and its corresponding range.

 CAUTION

The range will vary based on driving habits and road conditions.

Instruments panel controls

Control buttons

The instruments panel control buttons are on the right side of the steering wheel.



90E25AFF46EE

Hide alarm information



Press the  back button to hide the important alarm information currently displayed.

Press and hold the  back button to hide all important alarm information.

NOTICE

Alarm information, if any, on the instruments panel, must be hidden first. Otherwise, other instruments panel control functions are disabled.



Viewing audio-visual media information

Press the  left or  right button until the custom information is switched to the audio-visual media screen. At this point, you can view information for the current track or radio station.



View details of the Bluetooth telephone



Press the  left or  right button until the

custom information is switched to the Bluetooth telephone page. On the Bluetooth telephone page, you can do the following:

- › Press the  up or  down button to view individual call list entries for the Bluetooth telephone.
- › Press the OK button to dial the currently selected call list entry.

Set scenario mode

Press the  left or  right button until the custom information is switched to the scenario mode page.

On the scenario mode page, press the  up or  down button to switch the currently selected scenario mode. Press the OK button to activate the selection.



| Scenario mode | Application name | Privacy policy |
|---------------|------------------|---|
| Private mode | Map | <ul style="list-style-type: none"> › Hide search and navigation history. › Hide favourites history. › Hide search suggestion history. |
| | Mobile service | Hides information about incoming calls on the centre console display, the instruments panel displays incoming call alerts and your call list, use the steering wheel buttons to control Bluetooth call functions. |

speed, average energy, consumption, tyre pressure monitoring, etc.



- › Long press the OK button to view the sub-menu screen. On the menu page, you can view alarm information, set the alarm speed, and reset the travel information.

Press the  back button to go back one level.

View driving data information

Press the  left or  right button until the custom information is switched to the driving data page.

Press the  home button to return to the driving data page. On the driving data page, you can do the following:

- › Press the  home button to return to the driving data home page.
- › Press the  up or  down selector button to view driving data information on each page.

This includes information such as trip mileage, driving time, average vehicle

Vehicle equipment

Please note that this manual describes all standard equipment, country-specific equipment and special equipment for this series. Therefore, some equipment or functions described in this manual may not be installed in your vehicle or only available in certain markets. To learn more about specific configurations, please refer to sales documents or consult the dealer where you purchased the vehicle.

Instruments panel lights

NOTICE

- › When the vehicle power supply is switched to the ON mode, some indicator or warning lights will light up momentarily, indicating that the system self-test is in progress. This is normal.
- › Depending on the model configuration, not all lights or warning lights on the instruments cluster will light up.



Major warning message light
When this is illuminated, it indicates that the vehicle currently has a major warning message and that at least

one has been hidden intentionally.

WARNING

Don't ignore any warning messages. This could cause serious damage to the vehicle or result in an accident.

NOTICE

All the current warning messages in the vehicle can be viewed in the instruments panel warning messages screen.



Minor warning message light

When this is illuminated, it indicates that the vehicle currently has one or more minor warning messages.

WARNING

Do not ignore warning messages. This could cause serious damage to the vehicle or result in an accident.

NOTICE

- › Minor warning messages are automatically hidden after the instruments panel displays them for a few seconds.
- › All the current warning messages in the vehicle can

be viewed in the instruments panel warning messages screen.



Turn indicators

When the left turn light is operating, the left turn indicator flashes.

When the right turn light is operating, the right turn indicator flashes.

When the hazard warning lights are switched on, all the turning lights operate, and all the indicator lights on the outside of the vehicle will flash together.

CAUTION

If an indicator flashes quickly this usually means that the indicator is damaged and should be replaced as soon as possible, otherwise, other drivers will not see your signals.



Lighting indicator light

This light illuminates to show that the main lighting switch is on.



Sidelight light

This light illuminates to show that the sidelights and number plate light are switched on.



High-beam light

This light illuminates to show that high-beam is on.



High-beam/low-beam automatic switching light

When this light is on and the display is green, the high-beam/low-beam automatic switching function is on.

When this light is on and the display is yellow, there is a fault with the high-beam/low-beam automatic switching function. In such a situation, switch between high-beam and low-beam manually and visit an authorised service centre as soon as possible for service.



Rear fog lamp light

This light illuminates to show that the rear fog lamp is switched on.



Seat belt warning light

This light illuminates to warn that the driver, front passenger, or rear passenger is not wearing a seat belt.



Door ajar warning light

This light illuminates to show that a door or the bonnet is open or not fully closed.



Airbag fault warning light

This light illuminates to show

an airbag system fault. In such a situation, visit an authorised service centre as soon as possible for service.



Tyre pressure warning light

The light illuminates to show that a tyre pressure is low or a tyre is too hot, and is accompanied by an audible warning. In this case, park the vehicle, inspect and contact an authorised service centre.

This light illuminates after a period of time to show a fault in the tyre pressure monitoring system, accompanied by repeated audible warnings.

WARNING

If the light is on, avoid sharp turning or sudden braking, and drive to a safe place as soon as possible, park the vehicle and check.

Driving with low tyre pressure or overheating tyres could increase the possibility of damage to the tyres, and could even lead to serious damage to the vehicle or an accident.



Parking brake light

This light illuminates to show

that the parking brake is on.

This light flashes to show the brake disks are overheating or the road is too steep, and that there is a risk of the brakes slipping. Please press the brake pedal and stop on a flat road as soon as possible.



Parking brake fault warning light

This light illuminates to show there is a fault in the electrical parking brake system.



Automatic parking light

This light is yellow to show that the automatic parking function is in on/ready state. This light is green to show that the automatic parking function is operational.



Anti-lock braking system fault warning light

This light illuminates to show an anti-lock braking system fault. In this case, contact an authorised service centre.

When the light is on, the vehicle still has normal braking ability but no anti-lock function.



Brake system fault warning light

This light illuminates to show

that the brake fluid level is too low, the brake drive distribution system has a fault or the electronic braking assistance system is no longer effective.

At this point, immediately park the vehicle in a safe place and contact an authorised service centre. Otherwise, a serious accident could occur.



Electronic stability control system light

This light flashes to show that the electronic stability control system is in the operational state.

This light illuminates to show a fault in the electronic stability control system.



Electronic stability control system off light

This light illuminates to show that the electronic stability control system is off.



Electric power steering system fault warning light

When the light is illuminated and yellow, assisted steering effectiveness is reduced, and at this time a greater degree of force is needed to operate the steering wheel. If the light remains on after

restarting the vehicle or after driving a short distance, visit an authorised service centre as soon as possible for service.

When the light is red, this shows that the power steering system has developed a fault and that assisted steering has been lost. In such a situation, park the vehicle in a safe place and wait several minutes after the vehicle is switched off before restarting the vehicle. If the light is still on, visit an authorised service centre as soon as possible for service.

WARNING

When this light is illuminated and red, the power steering system will stop working. In such a situation, greater force is needed to steer the vehicle. Go to an authorised service centre as soon as possible for service.



Adaptive cruise control light

The light is white to show that adaptive cruise control is in the on/ready state.

This light is green to show that adaptive cruise control has been turned on and the

cruising speed has been set successfully.

i NOTICE

The figure in the lights will change as the cruising speed of the vehicle changes.



Intelligent cruise control light

This light is white to show that the intelligent cruise function is in the on/ready state.

This light is green to show that the intelligent cruise function is on and the cruising speed has been set successfully.



Side and rear assist system warning light

When the light is illuminated in yellow, this shows that a side and rear assist system sensor is covered. In this case, check for obstructions on both sides of the rear bumper and clear them away.

When this light is illuminated in red, this shows that there is a fault in the side and rear assist system. In such a situation, do not use the side and rear assist system. Go to an authorised service centre as soon as possible for



service.

Lane change assist light

This light illuminates to show that the lane change assist function is on.



Reversing side warning light

This light illuminates to show that the reversing side warning function is on.



Lane departure indicator light

When this light is green, this shows that the lane departure warning function is on. When this light is red, this shows that there is a fault with the lane departure warning function. In such a situation, do not use this function. Go to an authorised service centre as soon as possible for service.



Lane keep assist light

When this light illuminates green, this shows that the lane keep assist function is on.

When this light illuminates red, it shows that there is a fault in the lane keep assist function. In such a situation, do not use this function. Go to an authorised service centre as soon as possible for service.



Automatic emergency braking indicator light

An illuminated green light indicates that the automatic emergency braking function is on and working properly.

An illuminated yellow light indicates that there is a fault with the automatic emergency braking function. In such a situation, visit an authorised service centre as soon as possible for service.



Automatic emergency braking off indicator light

If this light is on, it indicates that the automatic emergency braking function is switched off.



READY light

This light illuminates to show that the vehicle has been started and can be driven normally.

If this light flashes, it indicates that the vehicle may have the following situations:

- › The vehicle has started but the driver's side door is open. In such a situation, close the driver's side door.
- › There is a serious fault that will affect normal driving. At this point, immediately park

the vehicle in a safe place and contact an authorised service centre.



Acoustic vehicle alert system warning light

When this light is red, it shows that there is a fault in the acoustic vehicle alert system. In such a situation, visit an authorised service centre as soon as possible for service.



Reduced power warning light

If this light is on, it indicates a drop in the vehicle's power output, so the vehicle's speed will be limited.

Driving at high speed or driving up an incline for long periods may cause the reduced power warning light to illuminate. In such a situation, reduce the speed or stop the vehicle and wait for a few minutes. If the indicator turns off, you can continue to drive, but if the indicator remains illuminated, visit an authorised service centre as soon as possible for service.



Low power battery charge light

This light illuminates to show that the power battery charge is too low. Please

charge it as soon as possible.



Charging state indicator light

When this light is red, the charging cable is connected but charging has not started.

When this light is green, the power battery is charging.



Power battery fault warning light

This light illuminates to show that there is a fault in the power battery. In such a situation, contact an authorised service centre as soon as possible.



Power battery failure warning light

This light illuminates to show that there is a fault in the vehicle causing an abnormal loss of power from the power battery.



DC/DC fault warning light

This light illuminates to show that there is a fault in the low-voltage charging system. In such a situation, visit an authorised service centre as soon as possible for service.



Powertrain system fault warning light

When this light is yellow it shows that there is a fault in the vehicle's power system.

At this point, immediately park the vehicle in a safe place and contact an authorised service centre.

When this light is red, this shows that the vehicle's power system has a serious fault and the vehicle cannot continue to be driven. In this case, contact an authorised service centre.



Drive motor fault warning light

This light illuminates to show that there is a fault in the drive motor system. In this case, contact an authorised service centre.



E-Park fault warning light

This light illuminates to show that there is a fault in the Park gear controller.



Braking energy recovery system fault warning light

This light illuminates to show that there is a fault in the braking energy recovery system.

Vehicle equipment

Please note that this manual describes all standard equipment, country-specific equipment and special equipment for this series. Therefore, some equipment or functions described in this manual may not be installed in your vehicle or only available in certain markets. To learn more about specific configurations, please refer to sales documents or consult the dealer where you purchased the vehicle.

System overview

The power management system monitors the power consumption of each electrical device within the vehicle and distributes power appropriately so as to improve the start-up performance of vehicle and prolong the life of the battery. The power management system has the following main functions:

› **Monitoring the 12V battery**

The voltage, current, and temperature of the 12V battery are continuously monitored by sensors, allowing residual charge and the health status of the battery to be calculated.

› **Power management when the vehicle is powered off**

While continuously monitoring the parked vehicle, the power consumption of each electrical device is gradually shut down according to battery monitoring information, to avoid the

12V battery becoming excessively discharged and to guarantee the start-up performance of the vehicle.

› **Power management when the power battery is off**

While continuously monitoring the vehicle when it is not running, the power consumption of each electrical device is gradually shut down according to battery monitoring information to avoid the 12V battery becoming excessively discharged and to guarantee the start-up performance of the vehicle.

› **Power management when the power battery is on**

The power consumption status of each electrical device is continuously monitored while driving and the electricity supplied by DC/DC is distributed to the various electrical devices according to demand. When the electricity supplied by DC/DC exceeds the requirements of the devices in use, power use is adjusted and power will be supplied to the 12V battery, ensuring that the battery charge remains optimal.

i NOTICE

The power management system is unable to change the laws of physics. Note that the output and lifespan of the 12V battery are both limited.

Things you should know

The power management system will give

priority to vehicle performance once started.

Short journeys, urban driving and low environmental temperatures increase electrical energy consumption and reduce the DC/DC power available.

If the vehicle is not started, due to DC/DC not being able to boost the supply of electricity, if an electronic device is in use, it will draw electrical energy directly from the 12V battery.

Under such circumstances you will notice the power management system coming into effect and restricting electrical supply and allocation.

Parking for long periods

If you do not drive the vehicle for several days or weeks, the power management system will gradually shut down or reduce the electrical supply to electrical devices, thus reducing power consumption and helping to prolong and maintain vehicle performance once started.

If the vehicle remains parked for a long period, some convenience functions (such as remote unlocking, etc.) may become inoperable. After starting the vehicle, these functions will be restored.

While the vehicle is not started

If you listen to the radio or use other functions of the audio-visual system while the vehicle is not started, this will drain the 12V battery.

If depletion of the 12V battery will affect

the vehicle's running, a warning message will appear on the multimedia screen or the instruments cluster. At this point, if you want to continue to use these functions, you will need to start the vehicle.

After starting the vehicle

While driving, even though DC/DC is supplying electricity, the 12V battery might still become drained. This situation can occur if electrical consumption is too high and the electricity supplied by DC/DC is insufficient, particularly so if the 12V battery charge was low in the first place.

In order to restore essential electrical supply, the system will temporarily shut down certain high-consumption electrical devices or reduce their electrical consumption. In particular, the heating system consumes a lot of power. If you find that the seat heating function is not working or that the A/C air flow is limited, this shows that the system has temporarily shut these down or adjusted them to a lower power output. Once the supply of electricity is restored, the systems will return to normal operation.

3

Audio-visual system

| | |
|--|-----|
| Safety notice..... | 158 |
| Introduction to the panel | 160 |
| Introduction to the display screen..... | 164 |
| Function introduction | 166 |

Safety notice

Vehicle equipment

Please note that this manual describes all standard equipment, country-specific equipment and special equipment for this series. Therefore, some equipment or functions described in this manual may not be installed in your vehicle or only available in certain markets. To learn more about specific configurations, please refer to sales documents or consult the dealer where you purchased the vehicle.

Safety

- › Using any function of this system should not distract the driver or result in unsafe driving. Safe driving is of paramount importance when operating the vehicle. Obey all traffic laws.
- › The driver should not interact with this system while driving. Additionally, keep the volume set to a level that will not distract the driver or have a negative impact on safe driving.
- › Only use this system in regions where it is permitted by law. Some national and regional laws may prohibit the use of a display that is in the driver's field of view.
- › Do not disassemble or modify this system.
- › If this system is not working, stop using it immediately and contact an authorised service centre. Do not repair it without authorisation.

Use

- › For your safety, some functions may not be available after the vehicle starts moving.
- › Do not use excessive force on the buttons or knobs.
- › Do not use excessive force or any sharp object to scratch the display.
- › Do not use any abrasive wipes or cleaners containing organic solvents to clean the display.
- › Do not hit the display if it flickers during use.

Radio

Road, weather and other environmental conditions may prevent the radio from finding stations, produce noise or distort the signal.

USB storage devices

We cannot guarantee that the system will be compatible with all USB storage devices due to the many different types on the market.

Bluetooth

- › Due to the many different types of mobile phones on the market and their differing functions, we cannot guarantee that the system will be compatible with all mobile phones.
- › If your mobile device cannot find this system's Bluetooth when pairing, restart the Bluetooth on your mobile device and try again.

- › If the Bluetooth cannot connect, delete the pairing from your mobile device and pair again.
- › If you experience any issues when using Bluetooth, disconnect the Bluetooth and then reconnect.

Introduction to the panel

Vehicle equipment

Please note that this manual describes all standard equipment, country-specific equipment and special equipment for this series. Therefore, some equipment or functions described in this manual may not be installed in your vehicle or only available in certain markets. To learn more about specific configurations, please refer to sales documents or consult the dealer where you purchased the vehicle.

Steering wheel buttons



78D24DAD93D0

- Ⓐ Left button
- Ⓑ Up button
- Ⓒ Right button
- Ⓓ Down button
- Ⓔ Mute button
- Ⓕ Play/Pause button
- Ⓖ Voice button
- Ⓗ Custom button
- Ⓘ Custom button

In addition to meeting the basic control requirements of the default scenarios, the steering wheel multimedia buttons can also meet vehicle control requirements in special scenarios and call scenarios to provide increased functionality.

Priority from high to low: Call scenario > Special scenario > Default scenario.

Call scenario

When receiving a call, press ◀ the left button to answer the phone. Press the ▶ the right button to hang up the call.

Special scenarios

Special scenarios provide steering wheel button operation prompts on the corresponding screens. Please follow the prompts.

Default scenario

The basic functions of the steering wheel buttons are as below:

- › When playing media: Press the **◀** left or **▶** right button to go to the previous/next track, and press and hold to fast forward/reverse.
When listening to the radio: Press the **◀** left or **▶** right button to search for the previous/next valid station, and press and hold the buttons to switch to the previous/next station saved.
- › Press the **⏮** up or **⏭** down button to increase/decrease the volume. Press and hold the button to continuously increase/decrease the volume.
- › Press the **⏸** play/pause button to play/pause multimedia.
- › Press the **🗣** voice button to turn system voice identification on or off.
- › Press the **🔇** mute button to mute or unmute audio-visual media.
Press and hold the **🔇** mute button to mute or unmute navigation.
- › Press the **⚙** custom button allows a pre-set function to be activated. Press and hold this button to enter the button function settings menu, where you can set the button's custom functions.
- › Press the **⚙** custom button allows a pre-set function to be activated. Press and hold this button to enter the button function settings menu, where you can set the button's custom functions.

Re-boot system

Simultaneously press and hold the down button **⏮** on the left side of the steering wheel and the **⏭** down button on the right side of the steering wheel for approximately 10 seconds to re-start the system.

i NOTICE

- › The audio-visual system and the instruments system will re-boot simultaneously.
- › In order to ensure safety during the re-boot process, the vehicle must be parked in a safe place, it should be placed in Park, and the parking brake applied, so that the vehicle remains stationary as the system re-boots.

External devices

USB port

This vehicle is equipped with dual USB ports and the position is shown in the diagram.



AB52700B9121

The ψ symbol indicates a USB data port.

i NOTICE

- ▷ Make sure that the connections of the external devices and the inputs port are stable.
- ▷ Do not connect or disconnect devices while playing media as this will lead to problems such as the system being unable to recognize the device correctly.

Media specifications

This system supports the following media specifications:

| Media | Specifications |
|-----------------|---|
| USB devices | USB devices formatted using FAT32, NTFS or ExFAT. |
| Bluetooth audio | Bluetooth 4.2 support (Bluetooth 4.2 is compatible with 2.1 and 3.0, Bluetooth low power is supported), Android Bluetooth protocol support version: A2DP 1.3、AVRCP 1.6、HFP 1.6、PBAP 1.2 |

File formats

The system supports the following file formats:

| File | Format |
|-------|------------------------------------|
| Audio | MP3, AAC, WAV, FLAC, APE, AMR, M4A |
| Video | MP4, MOV, 3GP, AVI, MKV |

i NOTICE

It is possible that due to the specific characteristics of the file (for instance quality, bit rate, frame rate, resolution, compression or damage), the playback environment

or the storage device, even if a file is in a format supported by this system, it may still not play normally.

Introduction to the display screen

Vehicle equipment

Please note that this manual describes all standard equipment, country-specific equipment and special equipment for this series. Therefore, some equipment or functions described in this manual may not be installed in your vehicle or only available in certain markets. To learn more about specific configurations, please refer to sales documents or consult the dealer where you purchased the vehicle.

Multimedia display







⚠ CAUTION

- › Only use the multimedia display where permitted by law. Some national and regional laws may prohibit the use of a display that is in the driver's field of view.
- › For your safety, some functions may not be available after the vehicle starts moving.
- › Do not use excessive force or any sharp object to scratch the display.
- › Do not use any abrasive wipes or cleaners containing organic solvents to clean the display.
- › Do not hit the display if it flickers during use.

Using the display screen

The central display uses simple gestures such as touching, swiping and dragging for functions such as selecting a target,

scrolling through a list or moving an application.

| Gesture | Action | Result |
|--|------------------------|--------------------------|
|  | Touch | Select or open |
|  | Long touch | Activate hidden function |
|  | Touch and swipe | Scroll or switch a page |
|  | Long touch and swipe | Move |
|  | Move two fingers apart | Zoom in |
|  | Pinch with two fingers | Zoom out |

Central display status bar

The status bar symbols are shown at the top of the central display and show the status of each function. Status bar symbols change in real-time based on function characteristics, signal strength, connection status or switch status.

| Symbol | Function status |
|--------|---|
| | Time display |
| | Temperature display |
| | 4G network signal, varies according to network status |
| | WLAN connected, displays signal strength |
| | New message notification |
| | Silent mode on |
| | Sound mode on |
| | Bluetooth not connected |
| | Bluetooth connected |
| | USB device connected |
| | Wireless charging ready |
| | Wireless charging in progress |
| | Wireless charging complete |

| Symbol | Function status |
|--------|---|
| | Steering wheel heating on |
| | Front left seat heating on |
| | Front right seat heating on |
| | Front left seat ventilation on |
| | Front right seat ventilation on |
| | A/C blower mode, varies with A/C status |
| | System update package downloading |
| | System update package download complete |
| | System update package download failed |

Vehicle equipment



Please note that this manual describes all standard equipment, country-specific equipment and special equipment for this series. Therefore, some equipment or functions described in this manual may not be installed in your vehicle or only available in certain markets. To learn more about specific configurations, please refer to sales documents or consult the dealer where you purchased the vehicle.

Screen overview

For convenience, a persistent menu bar is displayed on the left side of most pages.

- › Touch the  home button to switch to the homepage.

The system uses a dual homepage. After switching to the homepage, touch the  home button again to switch between driving scenario and entertainment scenario.

- › Touch the  all apps button to enter or exit the apps page.
- › Touch the  A/C button to enter or exit the screen for A/C and steering wheel heating settings.
- › Touch the  vehicle settings button to enter or exit the vehicle settings page.

NOTICE

The icons and functions on the persistent menu bar on the left may be different due to different model configurations or system versions. Please refer to the actual vehicle display.

- › Small thumbnails of recently used apps are displayed at the top. Touch a thumbnail to switch to the app screen.
- › App icons are displayed at the bottom. Tap one to switch to the app screen.

NOTICE

- › Some apps need to be connected to the network, and will consume data.
- › Some app screens may change if new content is added or their version is updated. Refer to the actual vehicle display.
- › System updates may increase or decrease the number of apps displayed on the menu screen.
- › Not all in-app features are free. Paid features include memberships, watching or downloading premium content and some designated products and services. The purchase of these items is optional.

› Some apps are developed by third parties, who are responsible for guaranteeing delivery of their products and services.

Shortcut screen

On most menus, the shortcut screen can be pulled out by sliding it down from the top of the screen.

Adjusting brightness and volume

【Navigation Volume】: touch the slider and drag to adjust the navigation volume. Touch the Δ^x mute button to mute or unmute the navigation.

【Media Volume】: touch the slider and drag to adjust the media volume. Touch the \square^x mute button to mute and unmute the media.

【Screen Brightness】: touch the slider and drag to adjust the screen brightness. Touch the \odot brightness adjustment button to turn the auto brightness adjustment on or off.

Shortcut buttons

The shortcut buttons are displayed on the right. Touch the button to switch to the corresponding function or turn it on/off. Long pressing some buttons will enter the corresponding settings page.

Touch 【Edit】 button to switch to the edit page and replace the shortcut button icon below.

Launcher screen

On most screens, swiping right from the left side of the screen brings up the launcher screen.

Global search

Touch the \mathcal{Q} global search button to switch to the global search screen. This allows you to perform a global search by entering key words when connected to the Internet.

Message centre

Touch the \square messages button to switch to the message centre screen to view received messages.

Weather details

Displays weather, temperature, temperature range, location and the time last

updated.

Recent apps

Displays icons of recently used apps. Touch the icons to quickly enter the app screen.

Mobility services

Displays map navigation shortcut buttons. Touch these to quickly set a destination or search.

Communication



Touch the **【Mobile Service】** button on the menu screen to switch to the communications menu. If you have not connected any other Bluetooth device, please proceed to the **【System Settings】** → **【Bluetooth】** screen to turn on Bluetooth and carry out pairing.

- › On the left side keyboard, after entering the phone number, press the  dial button to make a call.
- › Touch **【Contacts】** button, and after syncing, the contacts list is displayed. Touch a contact or number in the list to make a call.
- › Touch **【Recent Calls】** button, and after syncing, the recent calls list is displayed. Touch any entry in the list to make a call.
- › Touch **【Messages】** button, and after syncing, the message menu is displayed. Touch to view details of messages on currently connected devices.

NOTICE

- › To use the contacts and recent calls functions, you need to authorise it on the paired phone. Typically, when pairing, an authorisation window pops up on your phone.
- › On the **【System Settings】** → **【Bluetooth】** screen, deleting a paired Bluetooth device also deletes the contacts and call records from that device stored in the vehicle.

After establishing a call, switch to the call screen.

- › Touch  button to hang up the call.
- › Touch  button to turn the on-board microphone on or off.
- › Touch  button to switch between private or hands-free mode.
Private mode: Talk using a mobile phone connected to the system via Bluetooth.

Hands-free mode: Talk using the on-board speakers and microphone.

- › Touch  button to open or close the keyboard.

WARNING

To avoid an accident, the driver must always concentrate on driving the vehicle and must not be distracted by calls.

- › Use your Bluetooth phone only when road, traffic and weather conditions permit.
- › Adjust the volume so you can always hear outside signals, such as a police car or a fire truck.
- › Calls may not be available in areas with no network signal or where the signal is weak and in tunnels and garages.
- › If the driver needs to use his or her mobile device, first park the vehicle in a safe location.

System settings

Touch the **【System Settings】** button to switch to the system settings menu.

Bluetooth settings

- › **【Bluetooth Visibility】** : Touch to switch Bluetooth on or off. When enabled, this allows other devices to detect this system's Bluetooth, and to pair and connect to it.
- › **【Device Name】** : Displays the Bluetooth device name. You can edit a custom Bluetooth name.
- › **【Current Connection】** : Displays the Bluetooth device currently connected. You can disconnect or remove the connected device.
- › **【Available Devices】** : Displays the list of available Bluetooth devices that have been found. By touching the device name in the list, you can initiate a pairing request and pair.

Touch **【SEARCH】** button to search for Bluetooth devices again.

WLAN settings

- › **【WLAN】** : Turns the WLAN function on or off. When on, it displays a list of available connected devices.
- › **【Current Connection】** : Displays currently connected devices, touch **【DISCONNECT】** to disconnect a device.



Audio settings

- › **【System Sound】** : You can adjust navigation volume, voice volume, multimedia volume, and call volume; turn adaptive volume, multimedia sound reduction during navigation alerts, automatic broadcast of incoming calls, and system sound effects on or off; set the vehicle alarm sound and speed-based volume compensation.
- › **【Sound Effects】** : You can set the optimum listening position, the pedestrian alert sound and the volume of the equalizer, and turn stereo surround sound, active noise reduction and other functions on or off.
- › **【Voice Assistant】** : Displays the default voice wake-up word. You can set a custom wake-up word, and choose a voice for the voice assistant.

Display settings

- › **【Automatic Brightness Adjustment】** : turns this function on or off. When on, brightness automatically adjusts to whether the lamp is on or off.
- › **【Dashboard Brightness Control】** : For instruments panel brightness adjustments.
- › **【Center Console Display Brightness Control】** : Used for multimedia screen brightness adjustments.
- › **【Backlight Brightness Adjustment】** : For backlight brightness adjustments.
- › **【Display Mode】** : You can set the screen display mode to Automatic, Night, or Day.
- › **【Time Format】** : You can select the system time display format to 12 hours or 24 hours.
- › **【Time Zone Setting】** : Sets the time zone.
- › **【Language】** : Sets the system language.
- › **【Unit】** : Sets the units used for distance and speed.
- › **【Tyre Pressure Unit】** : sets the unit for tyre pressure.

Personalised settings

- › **【Dashboard Display】** : Sets the instruments panel display mode.
- › **【Steering Wheel [+] Customisation】** : You can choose a custom function for the  button on the steering wheel.
- › **【Steering Wheel [*] Customisation】** : You can choose a custom function for the  button on the steering wheel.

System messages

- › **【Version Info.】** : You can view and modify the device name, view the vehicle system software version, and check for updates over WIFI/4G and update the system.
- › **【Privacy Security】** : Set permissions relating to personal data.
- › **【Reset and Recover】** : You can reset the system settings or perform a factory reset.

i NOTICE

On updates and upgrades:

- › In order to ensure safety during the upgrade process, please place the vehicle in a safe environment.
- › To ensure a smooth update, ensure the vehicle power is in ON mode, the vehicle is in P gear, and apply the parking brake so that the vehicle remains stationary. Turn off electrical equipment that uses a lot of power (such as A/C, lights and speakers).
- › During the update process, please read the license agreement on the download page and Important Considerations on the installation menu carefully. If you would like to know more about this update, please click on the update details for more information.
- › During the update process, all functions of the vehicle will be unavailable, including: You will be unable to start the vehicle, use the A/C, open or close the doors, or use the video and audio entertainment functions; all the fault lights on the instruments panel will be on, and the active and passive safety functions will be offline. However, when the update is complete, all functions will be restored.
- › During the installation process, do not change the vehicle status (do not force the vehicle to start and do not force the system to turn off).
- › When updating via WIFI, ensure there is a good network signal and do not disconnect from the network during the update.
- › When you update the main unit or screen, the screen will go dark and re-start, this is normal. Just wait a few minutes for the head unit to finish re-starting, and a pop-up screen will show the installation result. Do not change the vehicle status during this time.
- › After updating, make sure that the update has been successful before closing the doors, locking the vehicle, and leaving. If the update fails or there is an error in

the update process, please contact an authorised service centre in a timely manner.

- › After the update is successful, the updated system items, functions, screens, operation methods, and so on may differ from those described in the manual. For updated content, refer to the menu prompts during the update process.

My account

On the menu page, touch the **My Account** button to switch to the personal settings page.

NOTICE

Some of the settings here can only be accessed using the owner's account (the account that has the crown on the profile photo).

Use the personal settings screen to log in or switch accounts, view and modify account information, set facial recognition information, access payment-related options, link third-party accounts, and view VIP centre information, the user agreement and the privacy policy.

Power assistant

Touch the **【Power Assistant】** button on the menu to switch to the power assistant page.

- › **【Power Flow】** : Displays power transfer status and total range.
- › **【Charging Management】** : Sets the Charging Mode and SOC limit of the power battery.
- › **【Driving Tips】** : Shows suggestions on economical driving and vehicle maintenance.

Voice assistant

The voice assistant can be used to rapidly control vehicle functions by identifying and executing voice instructions, thus making operating the vehicle more convenient.

You can start the voice assistant using the following methods:

- › Press the voice button  on the steering wheel.
- › Voice wakeup: Use the system default wakeup word or set a custom wakeup word.

For examples of wakeup words and voice instructions, go to the **【System Settings】** → **【Sound】** → **【Voice Assistant】** screen to view or set these.

WARNING

When using the voice assistant to control the functions of a vehicle, pay attention to the surrounding environment and personal safety so as to prevent serious accidents such as trapping injuries and collisions.

NOTICE

- › The success of voice identification will be affected by environmental noise, network signal, user habits, pronunciation and other factors. Its effectiveness depends on the actual vehicle usage environment.
- › Some voice assistant functions require a network connection to work properly.

Entertainment scenario

Touch the  home button on the persistent menu bar on the left and switch to the entertainment home page.

Touch the screen anywhere with three fingers and swipe to the left or right to switch between the entertainment home page and the driving home page.

- › **【Online Multimedia】** : Includes online music, online radio stations, online videos and other relevant apps. Apps are updated constantly, and the content and functions displayed may change.
- › **【Local Media】** : Includes local radio stations, Bluetooth music, USB music and USB videos.

To play Bluetooth Music, first go to **【System Settings】** → **【Bluetooth】** page, pair and connect other audio playback devices.

To play USB music and USB videos, insert the USB with the media files into the USB port (in the recess of the left side of the centre console).

NOTICE

- › To use the entertainment scenario functions, you need to log in and link to the correct account. Log in and link to the account following the screen prompts.
- › Playing paid-for content or purchasing memberships may incur charges, and you may purchase these accordingly.

There may be a delay after purchasing a membership due to network signal or other reasons. If the purchased access is not accessible after a few minutes, please re-boot the system.

› Using online audio and video as well as other network services may consume data.

Driving scenario

Touch the  home button on the persistent menu bar on the left to switch to the driving home page.



- (A) Destination search
- (B) Nearby charging piles
- (C) Nearby carparks
- (D) Range
- (E) Navigation settings
- (F) Mute navigation
- (G) Vehicle location
- (H) Map perspective
- (I) Map zoom
- (J) Map scale

Some function keys are automatically hidden if they have not been touched for a while. Touch any place on the map that is not covered by a button to reveal hidden function keys.

Selecting points on the map

Touch and hold the map to select a location and switch to the location details page.

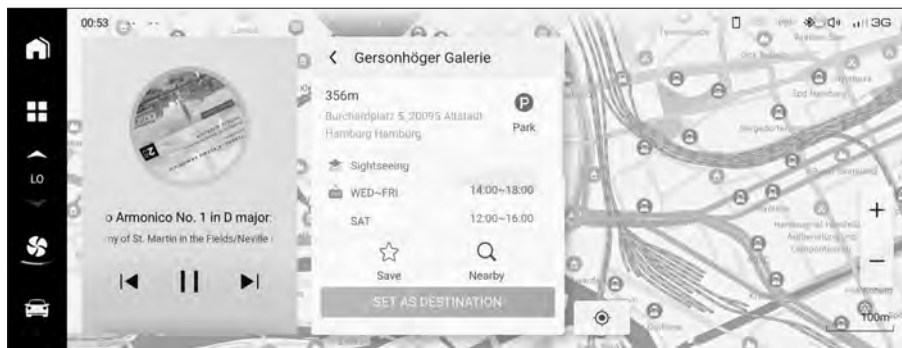

96C94FFD0DA

- › Touch the < back button to return to the previous page.
- › Touch the ☆ favourite button to save the current location. Touch the button again to remove it as a favourite.
- › Touch the 🔍 search nearby button to search in the area around the selected point.
- › Touch the **SET AS DESTINATION** button to set your current location as your destination.

Destination search

Touch the 🔍 search button on the map page to switch to the destination search page.

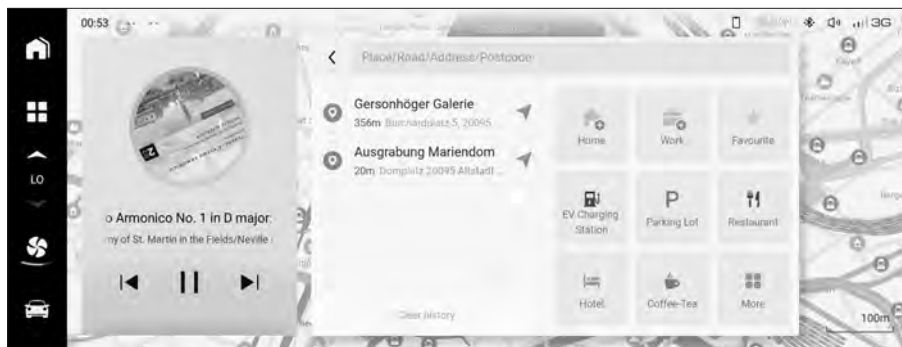

A681B8ACBFC

- › Touch the **Home** button to set your home location. After you have done this, touching this button will set your home address as your destination.
- › Touch the **Work** button to set your workplace location. After you have done this, touching this button will set your workplace as your destination.
- › Touch the **Favourites** button to switch to the favourites page to display locations added as favourites. You can view and delete locations added as favourites and set

any of them as your destination.

Route planning

After setting destinations using any available method, switch to the route planning page.

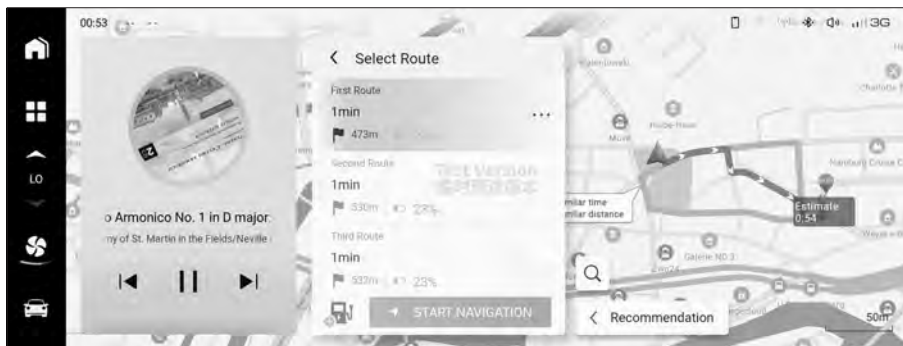

- › Touch the < back button to return to the previous page.
- › Touch the 🔍 search button to switch to the destination search page and add an intermediate destination or change your destination.
- › Touch the **【Recommendation】** button to display the route preferences menu and change your route preferences.
- › Touch the **【START NAVIGATION】** button to activate navigation mode for the current route.

Navigation settings

Touch the ⚙ settings button on the map page and switch to the navigation settings page.

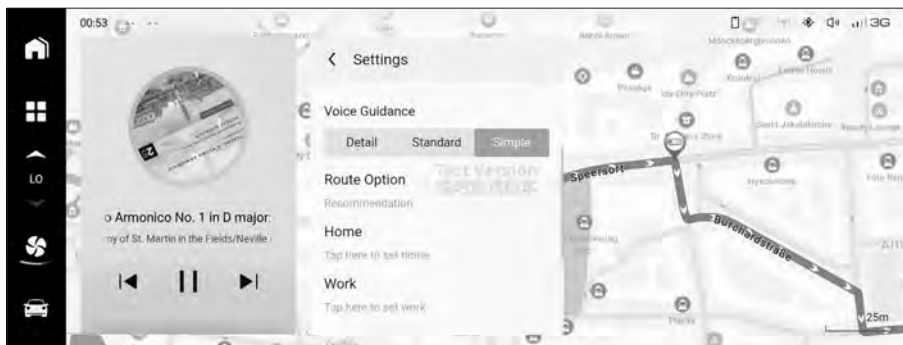



Traffic, auto zoom, 3D city mode, voice guidance, route option, home, work, clear personal data, version information, online map update, USB map update and other functions can be set here.

About navigation

- › We do not recommend interacting with the navigation system while driving. Use the screen after parking safely to avoid accidents or other dangers.
- › Functions and services including location search, route planning, trip navigation, traffic restriction alerts and traffic road conditions provided in this navigation system are for reference purposes only. Do not rely on these as your sole source of information when driving or going on a journey. Pay attention to actual traffic and road conditions and strictly observe traffic laws and regulations.
- › Online navigation, traffic conditions, data download and other services that require a network connection may consume network data.
- › If you use offline navigation in a vehicle without a network connection, some online functions and services will be unavailable (such as real-time traffic, and traffic restriction alerts etc.)

Skill tree

Touch the **【Skill Tree】** button on the menu interface to switch to the skill tree page. The skill tree page presents the function classification and extension relationship of the audio-visual system in a tree structure.

- › The vehicle's Bluetooth name is displayed at the centre of the skill tree. Touch the centre to change the Bluetooth name.
- › Touch the button on the skill tree to reveal drop-down functions and pop up a floating window showing the current function details. Touch and hold a button on the skill tree to hide all function buttons under that branch.
- › Touch the  return to centre button, and the menu will be restored to the default zoom level and will return the user to the skill tree centre view.
- › Touch the  search button to search for functions in the skill tree.
- › Touch the **【Auto-Learn】** button to turn the auto-learn function on or off.

E-manual

Touch the **【E-manual】** button to view the relevant content in the digital manual.

4

Safety & Security

| | |
|--|-----|
| Seat belts | 180 |
| Airbags | 184 |
| Child restraint system..... | 192 |
| Complete vehicle anti-theft system | 199 |
| Ultrasonic theft protection system | 201 |
| Vital signs monitoring | 202 |
| Emergency shut-off system | 204 |
| Event data recorder | 205 |
| Information security..... | 207 |

Vehicle equipment

Please note that this manual describes all standard equipment, country-specific equipment and special equipment for this series. Therefore, some equipment or functions described in this manual may not be installed in your vehicle or only available in certain markets. To learn more about specific configurations, please refer to sales documents or consult the dealer where you purchased the vehicle.

Safety notice

- › Do not place the seat belt's shoulder strap over the neck or under the armpit.
- › The lap belt should be as low as possible across the hips.
- › Each seat belt is intended for use by only one person at a time. Do not use a seat belt to strap in multiple people (including children).

If two or more persons wear the same seat belt and there is a collision, the seat belt cannot dissipate the impact, and the persons strapped in together may collide with one another.

- › The seat belt must not be twisted or be loose.
- › Do not pass the seat belt across sharp corners, otherwise it may be damaged in an accident.
- › Do not use a seat belt that has experienced a strong impact in an accident

or that has been damaged.

- › Do not dismount, dismantle or modify seat belts.
- › Do not use a seat belt that has a foreign object in the buckle.
- › Try to keep the seat belt clean. Keep oily and wet substances, including mud, oil, water, beverages and food crumbs, away from the seat belt to ensure that it extends and retracts smoothly.
- › Do not use benzene, petrol or other organic chemicals to clean seat belts, and do not bleach or dye them.
- › Do not allow children to play with the seat belts.

If a child accidentally wraps the seat belt strap around his or her neck, the seat belt strap may stop extending, which could result in serious personal injury or even death. If this happens and you cannot release the seat belt buckle, use scissors to cut the strap.

- › The seat belts are designed to fit adults, so use an appropriate child restraint system for children.

If the seat belt is positioned correctly but touches the child's neck or jaw and cannot be strapped across the hip, use a suitable child seat for the child.

A child who is large enough should use a seat belt as intended.

- › Pregnant women should note the following.

Ask your physician for his or her recommendation. Generally speaking, pregnant women should wear a seat belt the same way as others. However, the lap belt should be as low as possible across the hips, and the shoulder strap should pass across the shoulder and over the chest but not over the abdomen.

An incorrectly worn seat belt may cause serious injury or even death to the mother or unborn child or both during emergency braking or a collision.

- › Passengers who are sick or disabled should follow medical orders on how to wear a seat belt.
- › When a seat belt is not in use, it should be fully retracted. Do not twist or jam the seat belt, and keep the seat belt away from sharp objects. Do not allow any foreign object to obstruct the seat belt buckle, because this may affect the connection between the seat belt tongue and the buckle.

Correctly wearing your seat belt

- › Adjust the seat back so that you are sitting up straight with your back against the seat back.
- › The seat belt should be flat.
- › The shoulder strap should be close to the middle of the shoulder, not on the neck and not on the shoulder.

- › The lap belt should be as low as possible over the hips.

WARNING

- › All occupants in the vehicle must wear their seat belt correctly while the vehicle is moving. Otherwise, serious injury or even death may result during emergency braking or a collision because the body is not restrained in a seat.
- › All passengers should keep their seat belt fastened at all times, even during a short trip. Otherwise, there will be a greater risk of injury and even death in the event of an accident.

Pre-tensioner seat belts

During a collision, the pre-tensioner will instantaneously tighten the seat belt to provide the best restraint for the occupant.

The force limiter helps to control the load applied to the seatbelt, helping to minimise the impact to the chest.

Operating conditions

Pre-tensioner seat belts work when the vehicle is hit in the front by a strong force.

If the vehicle is subjected to one of the following impacts and the impact force is small, the seat belt may not deploy.

- › Frontal collision against a solid wall at a speed of 25 km/h or less.
- › Frontal collision with an object with a

small surface area, such as a telephone pole or a tree, at a speed of 35 km/h or less.

Pre-tensioner seat belts may not work as expected when the vehicle experiences one of the following forceful impacts.

- › The vehicle has rolled 90° or 180°.
- › During a side or rear collision.

⚠ WARNING

- › Wear the pre-tensioner seat belt correctly and adjust the seat to the optimal position. Otherwise, the seat belt may not work properly, which could cause serious injury or even death.
- › If you want to install, remove or disassemble a pre-tensioner seat belt, contact an authorised service centre. Using a pre-tensioner seat belt improperly may cause it to malfunction, which may result in serious injury or even death in the event of an accident.
- › Pre-tensioner seat belts may not be reused.

After the first collision, the pre-tensioner cannot extend or retract for a later collision. Please contact an authorised service centre for a replacement.

- › When a pre-tensioner seat belt deploys, you will hear a loud explosion and see white smoke. This will not cause a fire and is harmless to the human body.

- › Please contact an authorised service centre to scrap a pre-tensioner. Because a pre-tensioner seat belt that deploys unexpectedly during scrap can cause injury.

How to use the three-point seat belt

1. Grasp the hasp and pull the seat belt out of the retractor, making sure that you do not twist the seat belt. If the seat belt cannot be pulled out from the retractor, the seat belt should be pulled hard and then released, to cause the seat belt to be rewound, then it will be possible to pull the seat belt smoothly from the retractor.
2. Insert the hasp into the buckle and make sure you hear a click.



3. Pull the shoulder belt upwards, and adjust the waist belt to ensure a snug fit. This will reduce the possibility of injury to the pelvis in a collision.

4. Adjust the shoulder belt so that it fits snugly over the front of the chest and across the middle of the shoulder. By doing so, the force of any collision will be distributed across the strongest part of the upper body.
5. To retract the seat belt, press down on the release button on the top of the buckle. Once released from the buckle, hold on to the hasp until the seat belt is completely rewound to prevent it hitting other passengers or objects close by.

Vehicle equipment

Please note that this manual describes all standard equipment, country-specific equipment and special equipment for this series. Therefore, some equipment or functions described in this manual may not be installed in your vehicle or only available in certain markets. To learn more about specific configurations, please refer to sales documents or consult the dealer where you purchased the vehicle.

Safety notice

- › Airbags cannot be used more than once.

After deploying once, an airbag will not work again in another collision. Contact an authorised service centre for a replacement.

- › Airbags are supplementary devices for the safety of vehicle occupants and should be used in conjunction with seat belts. Occupants must wear their seat belt and sit with the correct posture for airbags to function properly and offer protection.
- › Airbags must be used properly to protect occupants. If used improperly, they may lose their ability to protect the safety of occupants and may cause injury.
- › When an airbag inflates, there will be a loud explosion and smoke, but this will not cause a fire. A person suffering from a respiratory disorder such as asthma who inhales this smoke may have difficulty breathing. In such a case, it would be safer to move away from the vehicle as soon as possible. If unable to leave the vehicle, open a window or door to let in fresh air.
- › If any product of the airbag inflation (for example, gas) gets into your eyes or on your skin, flush with clean water as soon as possible. Otherwise, an individual with sensitive skin may experience an allergic reaction.
- › Do not touch airbag components after it has inflated. Some components will be very hot and may cause a serious burn.
- › Do not use an airbag for any other purpose.
- › If you need to install a radio transceiver, contact an authorised service centre. Electromagnetic waves from a radio transceiver can seriously affect the control unit of an airbag.
- › Do not use force or apply pressure to an airbag or its surrounding area.

This helps to prevent the airbag from failing to function properly during an accident or from deploying when there is no accident, which could cause serious injury and even death to passengers.

Airbags

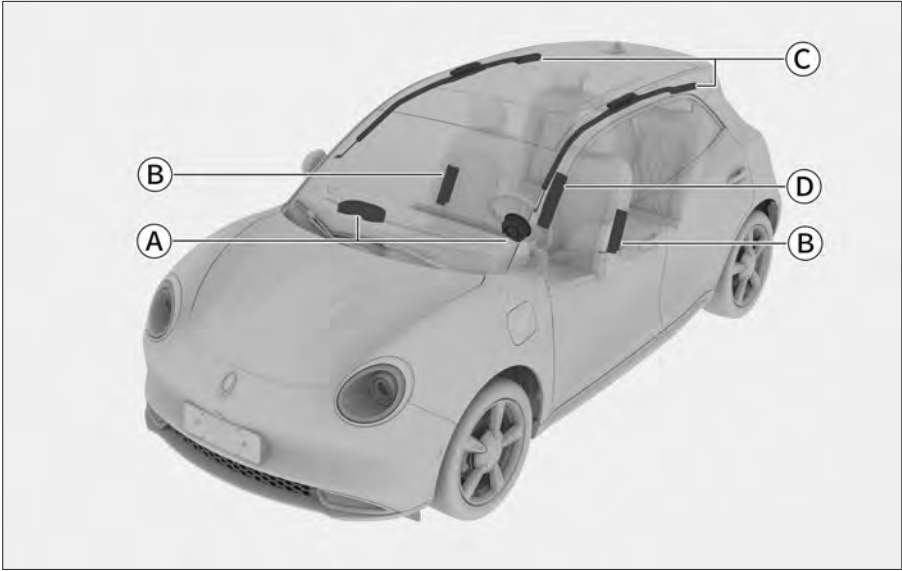

35DDE47C1F46

- Ⓐ Front airbags, including:
 - Driver airbag
 - Front passenger airbag

- Ⓑ Side airbag
- Ⓒ Curtain airbag
- Ⓓ Central airbag

Front airbags

Description

The front airbags are inside the steering wheel and the instrument panel in front of the front passenger seat. There are airbag symbols on the steering wheel and the instrument panel. When the vehicle has a strong frontal collision, the seat belts lock and the driver-side and passenger-side airbags inflate to dissipate and retard the impact on the head and chest of the vehicle occupants.

The driver's knee airbag is under the instrument panel, on which there is an airbag symbol. The driver's knee airbag acts as a supplement to the seat belt. In the event of a collision, the knee airbag protects the driver's knees and calves and stabilizes the driver's posture.

CAUTION

Adjust the driver's seat so that there is at least 10 cm between the driver's knees and the instrument panel. If this minimum distance is not possible for physical reasons, contact an authorised service centre for help.

Operating principle

In the event of a moderate to severe frontal collision, sensors perceive that the vehicle is decelerating rapidly, and the control unit immediately commands the airbag to inflate instantaneously.

Precautions

- › The airbags may inflate if the bottom of the vehicle experiences a strong impact such as:
 - 1) When the vehicle hits a kerb.
 - 2) When the vehicle falls into or crosses a deep hole or trench.
 - 3) When the vehicle impacts the road surface after climbing over a step.
- › When the vehicle rolls 90° or 180°, the airbag may inflate, but will not be effective.
- › The airbags may not inflate if the vehicle experiences a strong impact from one of the following:
 - 1) A frontal collision against a concrete wall at a speed less than 25 km/h.
 - 2) A frontal collision with an object with a small surface area, such as a fixed utility pole or a tree, at a speed less than 35 km/h.
- › The deformation or movement of the object that the vehicle collides with reduces the impact of the collision. This may cause the airbag not to inflate. If the vehicle hits a lorry from behind and gets pinned under the trailer, the sensors will detect a weaker impact, and the airbags may not inflate.
- › Even when the vehicle's speed is high, the airbags sometimes do not deploy because of the angle or direction of the collision.
- › Do not sit too close to the steering

wheel or instrument panel.

Under normal driving conditions, the driver should maintain good posture while keeping an appropriate distance from the steering wheel.

The front seats should be as far away as possible from the instrument panel.

All occupants in the vehicle should wear their seat belt properly as a protective restraint.

- › When driving, passengers should not sit on the edge of the seat or lean against the instrument panel.

This is because the front airbags inflate very rapidly and with great force and may harm or kill a passenger sitting too close.

- › Children should not stand in front of an airbag.

An airbag may harm or kill a child when it inflates. All children should sit in the rear seat and wear their seat belt properly as a protective restraint.

- › Note the following precautions, otherwise these items may cause serious injury to the occupants when an airbag inflates:

1) Do not place objects on the instrument panel or place objects such as umbrellas close to the instrument panel.

2) Do not leave the glove compartment open.

3) Do not hang any object from the

window glass or interior rearview mirror.

4) Do not place ornaments on the steering wheel horn.

5) Do not place any luggage, pets or other items between the airbag and the driver or front passenger.

- › Do not use water or cleansers to clean the interior of the vehicle.

The airbag module is the device that inflates the airbag. If it gets wet, it will affect the operation of the airbag and may cause serious injury or even death.

- › Do not apply anything like sealing wax or film over the airbag covers.

Otherwise, this may prevent the airbag from inflating normally.

- › Do not damage the airbag cover.

Otherwise, it will not work properly. Therefore, never open or damage the air-bag cover without professional assistance.

- › Do not disassemble, modify or install any airbag, instrument panel, steering wheel or other installed devices.

Improper use may cause an airbag to fail or unexpectedly inflate, which may cause serious injury or even death.

- › Do not modify the suspension.

Modifying the vehicle height or the suspension's rigidity may cause the airbags to inflate incorrectly, which may result in serious injury or even

death.

- › For installation of protective plates and air direction plates on the front of the vehicle, consult an authorised service centre.

Modifying the front of the vehicle may change the impact detected by the airbag sensor. This would cause the airbag to inflate incorrectly, which may result in serious injury or even death.

- › For repairs to the front of the vehicle or the passenger compartment, consult an authorised service centre.

An improperly completed repair may change the impact detected by the airbag sensor. This would cause the airbag not to work, which may result in serious injury or even death.

Side airbags

Introduction

The side airbags are in the outer cushion of the seat back and marked with an airbag symbol. Side airbags are a supplement to seat belts. In the event of a side collision, the side airbags reduce injuries of the occupants in the vehicle and prevent further impacts.

Operating principle

In the event of a side collision, a sensor perceives the sharp change in the lateral acceleration of the vehicle and sends a signal to the control unit. If the conditions for inflation are met, the side airbags instantly inflate.

In the event of a side impact, only the side airbag on the impacted side will inflate. If the impact occurs on the passenger side, the side airbag on the passenger side will inflate even if there is no passenger on the seat.

Note

- › If the vehicle is subjected to one of the following impacts and the impact force is small, the side airbag sometimes will not inflate:
 - 1) Frontal collision.
 - 2) A minor side collision that sends a weak signal to the control electronics.
 - 3) Rear impact.
 - 4) Roll-over.
- › Do not cover a side airbag with any object. Otherwise, the side airbag may not function properly.
- › Do not install any object near where the side airbags will inflate. Otherwise, there is a risk that the object may launch into the cabin if the side airbag inflates.
- › Do not disassemble, repair or modify equipment on the seats with the side airbags or parts around the inflation area of the side airbags without professional assistance.

Warning label



This label is located on the door pillar to remind you that the car is equipped with side airbags. Please pay attention to the relevant matters.

Curtain airbags

Introduction

The curtain airbags are located along the lower edge of the roof, and there are airbag symbols marked on the pillars. Curtain airbags are a supplement to seat belts. In the event of a side collision, the curtain airbags reduce head injuries of the occupants in the vehicle and prevent further impacts.

Operating principle

In the event of a side collision, a sensor perceives the sharp change in the lateral acceleration of the vehicle and sends a signal to the control unit. If the conditions for inflation are met, the curtain airbag on the side of the collision instantly inflates.

Note

- › If the vehicle is subjected to one of the

following impacts and the impact force is small, the curtain airbag sometimes will not inflate:

- 1) Frontal collision.
- 2) A minor side collision that sends a weak signal to the control electronics.
- 3) Rear impact.
- 4) Roll-over.

- › Do not get close to the side of the vehicle door, pillar or roof or kneel on the front passenger seat. Otherwise, the curtain airbag may strongly impact your head when it inflates, which may cause serious injury or even death. Pay particular attention when children are in the vehicle.

- › Do not install any object near where the curtain airbags will inflate. Otherwise, there is a risk that the object may launch into the cabin if the curtain airbag inflates.

- › Do not hang any heavy or sharp object on the clothes hooks.

When hanging clothes, please hang directly on the hooks instead of hangers. Otherwise, the hanger could be in a risk of flying up when the curtain airbag inflates.

- › Do not disassemble, repair or modify the parts around the inflation area of the curtain airbags without professional assistance.

Do not modify the ceiling, grab handles, grab handle brackets or side

interior roof lights without professional assistance.

Seat-mounted side airbags

Introduction

The seat-mounted side airbag is in the outer cushion of the driver's seat back (facing away from the door) and is marked with an airbag symbol. In the event of a side collision, the seat-mounted side airbag will inflate to mitigate injury caused by the driver and passenger colliding with one another or by the driver colliding with the passenger-side door or frame. This can protect critical body parts such as the head and chest.

Operating principle

In the event of a side collision, a sensor will detect the sudden change in the lateral acceleration of the vehicle and send a signal to the control unit. If the conditions for inflation are met, the seat-mounted side airbag will inflate instantly.

Note

- › If the vehicle suffers one of the following impacts and the impact force is small, the seat-mounted side airbag will not always inflate:
 - 1) Frontal collision.
 - 2) A minor side collision that sends a weak signal.
 - 3) Rear impact.
 - 4) Roll-over.

- › Do not place anything over a seat-mounted side airbag. Otherwise, the seat-mounted side airbag may not function properly.
- › Do not install any object near where the seat-mounted side airbag will inflate. Otherwise, there is a risk that the object may be propelled into the cabin if the seat-mounted side airbag inflates.
- › Do not disassemble, repair or modify any seat equipment with the seat-mounted side airbag or parts around the inflation area of the seat-mounted side airbag without professional assistance.

Front passenger airbag switch



2E7E7EB8DCCF

The front passenger airbag switch is located on the side of the dashboard on the passenger side.

When the mechanical key is used to rotate the front passenger airbag switch to the OFF position, the front passenger airbag can be turned off. At this time, the passenger airbag OFF warning light

 illuminates over the reading light.

When the mechanical key is used to rotate the front passenger airbag switch to the ON position, the front passenger airbag can be turned off. At this time, the passenger airbag ON warning light  illuminates over the reading light.

NOTICE

After inserting the mechanical key, you must push the mechanical key in the insertion direction, then it can be rotated normally.

WARNING

- › When the front passenger airbag status is ON, a rear facing child seat must not be installed on the front passenger seat. Doing so may result in serious injury or even death.
- › If under special circumstances a rear facing child seat must be installed on the front passenger seat, make sure to turn off the front passenger airbag. The failure to do so can result in serious injury or even death.

Under other circumstances the front passenger airbag switch should not be turned to the OFF position, as this would prevent the front passenger airbag deploying in a serious collision.

Child restraint system

Vehicle equipment

Please note that this manual describes all standard equipment, country-specific equipment and special equipment for this series. Therefore, some equipment or functions described in this manual may not be installed in your vehicle or only available in certain markets. To learn more about specific configurations, please refer to sales documents or consult the dealer where you purchased the vehicle.

Recommended child seat types

i-Size and ISOFIX are vehicle child safety seat installation systems based on international standards. In the nation where you are located, child seats are governed by the ECE-R44 and ECE-R129 standards, and these two standards apply simultaneously. ECE-R44 is that based on child weight, and ECE-R129 is based on child height. Only child seats that meet the standards are permitted to be used in vehicles.

By weight group

| Group | Weight (kg) |
|-------|---------------|
| 0 | Maximum of 10 |
| 0+ | Maximum of 13 |
| I | 9 to 18 |
| II | 15 to 25 |
| III | 22 to 36 |

Height group

Child seats classified by height must

conform to the provisions and requirements related to installation and safety of the ECE-R129 standard. For the specific height classification and applicable seats, please refer to the child seat instructions or consult the child seat manufacturer.

Recommended child seats

| Group | Manufacturer | Type | Notes |
|---|--------------|------------|-------------------|
| 0 Maximum of 10 kg | Maxi Cosi | Cabrio-fix | Belted |
| 0 + Maximum of 13 kg | Maxi Cosi | Cabrio-fix | Belted |
| I 9 to 18 kg | Britax Römer | King II LS | ISOFIX and Belted |
| II 15 to 25 kg | Britax Römer | Kidfix 2S* | ISOFIX and Belted |
| III 22 to 36 kg | Osann | UP | Belted |
| *: Be sure to attach the seat belt through the SecureGuard. | | | |

i NOTICE

For optimal protection, we suggest that one of the recommended child seat types be used, including rear and waist

strap guides.

It may not be the case that selection of child seat according to weight group is appropriate for all children, also, not every child seat may be right for your vehicle. Therefore, you must check whether the child seat is suitable once the child is seated, and whether or not the child seat can be fixed securely within the vehicle.

Child seat safety instructions

Warning sticker



This sticker is located on the front passenger side sun visor to remind you that your vehicle is equipped with a front airbag. Please note the related matters.

⚠ WARNING

Do not use a backward facing child restraint system on a seat protected by a front airbag (when activated), since doing so may result in death or serious injury to the child.

› If a child seat anchorage is not used to install the child seat, use the seat belt

for installation, install according to the installation instructions attached to the child seat.

› Please fix the child seat securely to the vehicle in the correct manner.

Failure to correctly install a child seat can easily cause serious injury or even death during sudden braking or in a collision.

› Do not place an unsecured child seat in the vehicle.

If you continue to keep it in the vehicle, it can easily hit passengers or other objects during sudden braking or in a collision, which could cause serious injury or even death.

› Even if the child is seated in the child seat, make sure that neither the child's head nor any part of its body can rest against a door pillar, or the roof or side of the car.

If a curtain airbag deploys this is extremely dangerous, and the force of its impact may cause severe injury or even death.

› Since there are many kinds of child seat, refer to the installation instructions accompanying the child seat and operate according to the precautions when installing and disassembling it.

› Make sure there is plenty of space around the child seat and, if necessary adjust the front seat.

› If a cushion is used to increase the height, do not remove the headrest,

the top of the headrest should be adjusted to a position that is at or near the top of the child's head.

⚠ WARNING

When a child seat is used on the front passenger seat, the following instructions must be followed.

- › When a child seat is installed on the front passenger seat, the front passenger airbag should be turned off. Once a child seat is removed from the front passenger seat, the front passenger seat airbag should be turned back on immediately.
- › If necessary, adjust the seat backrest angle until stable contact exists between the seat backrest and the child seat.
- › When a child seat is installed in the front row, if necessary (e.g. a situation where there is interference between the child seat and the interior decor) you can undertake front-rear adjustment or backrest angle adjustment for the seat. [see above]
- › Pay attention so that the seatbelt does not get tangled when it passes through the guide fitting and is not twisted over the guide fitting.
- › For child seats of groups II and III, ensure that the guide device on the child seat headrest is positioned in front of the upper seat-belt fixing point on the B pillar.

When a child seat is used on the rear row seat, the following instructions must be followed.

- › When a child seat is installed in the back row, if necessary (e.g. a situation where there is interference between the child seat and the front row seat) you can undertake front-rear adjustment or backrest angle adjustment for the front row seats. [see above]

Child seat fixing points

Child seat lower fixing points



D0A255CECECS

There are two sets (4) of child seat lower fixing points in the gaps between the seat backrests and the seat cushions on both sides of the back row. Before use, the protective covers between the backrests and the cushions on the two sides must first be uncovered.

Child seat top tether anchorage points



F4F4588DFB03

For each of the 2 outboard seats, this anchorage is part of the Isofix or i-Size CRS installation to be used in conjunction with the child seat lower fixing points. The use of the top tether anchorage point with a belted child seat is only allowed in specific market such as Australia.

⚠ WARNING

The child seat fixing points are only designed to withstand loads exerted by correctly installed child seats. Under no circumstances may they be used for adult seatbelts, slings, or for the connection of other items or devices to the vehicle.

Child seat installation

When installing a child seat, you must use a child safety seat that is appropriate for the child's age, weight, and size.

Using seat belt installed child seats

The table below lists the details of the suitability of individual seats installed in the vehicle using seat belts.

| Group | Seat position | | | |
|--------------------|--------------------------------|---------------------------------|---------------------|------------------|
| | Front passenger seat | | Rear passenger seat | |
| | Front passenger side airbag on | Front passenger side airbag off | Rear outside seat | Rear middle seat |
| 0 Up to 10 kg | X | U | U | U |
| 0 + Up to 13 kg | X | U | U | U |
| I 9 to 18 kg | X | U | U | U |
| II 15 to 25 kg | X | U | U | U |
| III 22 to 36 kg | X | U | U | U |

Note: The letters in the table have the following meanings:

U - This seat satisfies the "universal" child seat category, and can be used for this weight group.

X - This position is not suitable for child seats.

1. When a child seat is installed in the front seat, when necessary (i.e.: if

the child seat interferes with the interior trim, etc.), the seat can be adjusted backwards and forwards and the angle of the seat back can be adjusted.

2. When a child seat is installed in a rear seat, if necessary (i.e.: if the child seat interferes with the front seat etc.), the front seat can be adjusted backwards and forwards and the angle of the seat back can be adjusted.
3. If necessary, adjust or remove the headrest when installing the child seat to avoid it interfering with the child seat, preventing a firm fit between the child seat and the seat back.
4. Pull out the seat belt, fit it correctly in the child seat, insert the tab into the buckle and make sure you hear a 'click'.
5. Press the child seat against the seat and tighten the seat belt to ensure that it is not loose.
6. Gently rock the child seat to confirm it is locked solid.

Installing a child seat using a fixed child seat installation

ISOFIX and i-Size are standard protection systems designed specifically for child seats. The table below lists details of the suitability of individual ISOFIX or i-Size standard child seats.

Details of suitability of ISOFIX child seat

| Group | Child seat size category | Seat position | | | |
|--------------------|--------------------------|---------------------------------|----------------------------------|---------------------|------------------|
| | | Front passenger seat | | Rear passenger seat | |
| | | Front passenger side air-bag on | Front passenger side air-bag off | Rear outside seat | Rear middle seat |
| 0 Up to 10 kg | G/F/E | X | X | IL | X |
| 0+ Up to 13 kg | E/D/C | X | X | IL | X |
| I 9 to 18 kg | D/C/B/B1/A | X | X | IL | X |
| II 15 to 25 kg | - | X | X | IUF | X |
| III 22 to 36 kg | - | X | X | IUF | X |

| Group | Child seat size category | Seat position | | | |
|---|--------------------------|--------------------------------|---------------------------------|---------------------|------------------|
| | | Front passenger seat | | Rear passenger seat | |
| | | Front passenger side airbag on | Front passenger side airbag off | Rear outside seat | Rear middle seat |
| <p>Note: The letters in the table have the following meanings:</p> <p>IL - This seat is suitable for recognised "semi-universal" ISOFIX child seats.</p> <p>IUF - The seat is suitable for use with forward facing child seats and can be used with this weight group.</p> <p>X - This position is not suitable for ISOFIX child seats.</p> | | | | | |

Details of suitability of i-Size child seat

| Seat position | | | |
|--------------------------------|---------------------------------|---------------------|------------------|
| Front passenger seat | | Rear passenger seat | |
| Front passenger side airbag on | Front passenger side airbag off | Rear outside seat | Rear middle seat |
| X | X | i-U | X |

| Seat position | | | |
|---|---------------------------------|---------------------|------------------|
| Front passenger seat | | Rear passenger seat | |
| Front passenger side airbag on | Front passenger side airbag off | Rear outside seat | Rear middle seat |
| <p>Note: The letters in the table have the following meanings:</p> <p>i-U - For forward or backward facing i-Size child seats.</p> <p>X - This position is not suitable for i-Size child seats.</p> | | | |

1. When a child seat is installed in a rear seat, if necessary (i.e.: if the child seat interferes with the front seat etc.), the front seat can be adjusted backwards and forwards and the angle of the seat back can be adjusted.
2. If necessary, adjust or remove the headrest when installing the child seat to avoid it interfering with the child seat, preventing a firm fit between the child seat and the seat back.
3. Slide the child seat locks into the lower fixing points and ensure the two ISOFIX locks are properly secured.
4. When securing the strap, refer to the child seat instructions.
5. Gently rock the child seat to confirm it is locked solid.

⚠ WARNING

- › If the child seat is equipped with an upper strap, be sure to fasten the upper strap in accordance with the safety installation instructions and precautions for that child seat. Otherwise, this could cause serious injury or even death when sudden braking or a collision occurs.
- › Do not lower the headrest after fastening the strap on the child seat fixing point. Otherwise, when sudden braking occurs or in the event of a collision, otherwise contact with the headrest could slacken the belt, leading to the child seat twisting, which could cause injury or even death.

Vehicle equipment

Please note that this manual describes all standard equipment, country-specific equipment and special equipment for this series. Therefore, some equipment or functions described in this manual may not be installed in your vehicle or only available in certain markets. To learn more about specific configurations, please refer to sales documents or consult the dealer where you purchased the vehicle.

System description

The vehicle anti-theft system helps prevent your vehicle and valuables from being stolen. If someone tries to break into the vehicle, the audible and visual alarm will be triggered.

WARNING

Do not modify the vehicle anti-theft system.

Usage

System on

1. After the door is successfully locked by the button on the key, by the intelligent entry system or by the mechanical key, the vehicle enters the pre-armed state.

In the pre-armed state, any vehicle operation can still be performed without triggering the anti-theft alarm.

2. After remaining in the pre-armed state for about 15 seconds, the vehicle will automatically enter the anti-theft state and the vehicle anti-theft system will be turned on.

CAUTION

To ensure that the vehicle anti-theft system is turned on, check that all windows and doors are locked before leaving the vehicle.

NOTICE

Once in the pre-armed state, the central locking button will no longer function.

Conditions for triggering the alarm

Once the anti-theft state is set, the following behaviour can trigger the alarm:

- › If the mechanical key is used to open the door.
- › If the doors or boot lid are opened by force.
- › If the power supply mode is changed from OFF to ON.
- › If the bonnet is opened.

Method for turning off the alarm

After the anti-theft alarm is triggered, the alarm can be turned off in the following manner:

- › By smart key verification.
- › When the power supply mode is OFF, unlock the doors or boot lid using the

button on the key or the intelligent entry system.

System off

Once the doors or boot lid are unlocked with the button on the key or the intelligent entry system, the anti-theft functions are turned off.

Vehicle equipment

Please note that this manual describes all standard equipment, country-specific equipment and special equipment for this series. Therefore, some equipment or functions described in this manual may not be installed in your vehicle or only available in certain markets. To learn more about specific configurations, please refer to sales documents or consult the dealer where you purchased the vehicle.

Usage

System on

Go to **【Vehicle Settings】** → **【Body】** on the multimedia display to turn ultrasonic theft protection on or off.

After locking the vehicle door using the button on the key, the smart entry system or the mechanical key, the ultrasonic theft protection function turns on after anti-theft has been switched on for about 40 seconds for the vehicle. After turning on, if the system detects an unauthorised entry into the vehicle (such as a break-in through a window), the alarm will sound.

CAUTION

To ensure that ultrasonic theft protection is turned on, check that all the windows and the sunroof are closed and the doors are locked before leaving the vehicle.

Method for turning off the alarm

Unlock the vehicle with the smart key.

Avoiding false alarms

Functions intended to protect the vehicle may trigger false alarms. For the following examples, we advised that you turn off such functions:

- › During a car wash.
- › In a stacked parking spot.
- › When transporting the vehicle with on a train, ferry or lorry.
- › When there are pets or moving objects inside the vehicle.
- › When the vehicle is shaken or a false alarm is triggered by external vibration.

In order to avoid a false alarm, turn off ultrasonic theft protection. To do so, lock the vehicle by pressing the smart key, then press the lock button again within 2 to 5 seconds.

Vital signs monitoring

Vehicle equipment

Please note that this manual describes all standard equipment, country-specific equipment and special equipment for this series. Therefore, some equipment or functions described in this manual may not be installed in your vehicle or only available in certain markets. To learn more about specific configurations, please refer to sales documents or consult the dealer where you purchased the vehicle.

Function overview

Go to **【Vehicle Settings】** → **【In-Car】** → **【In-Cabin Monitoring】** on the multimedia display to modify settings for vital signs monitoring.

- › **【VMDR Biometric Identification】** : temporarily turns vital signs monitoring on or off.

When on, the sensors start to check the interior of the vehicle when the power supply mode is in OFF mode, all the windows are closed and the doors are locked. If vital signs of a passenger or animal are detected, the vehicle will send out an alarm signal to the driver to ensure the security of the passenger or pet left in the vehicle.

i NOTICE

Every time you switch the power mode to ON, vital signs monitoring is turned on by default.

- › **【Delayed Shutdown】** : turns the alarm delay function on or off.

When on, the vital signs monitoring system will delay the alarm by 10 minutes.

i NOTICE

- › The function is an auxiliary alert, it cannot prevent injuries or deaths due to passengers or animals being left in the vehicle on its own. Please check the inside of the vehicle before leaving.
- › Please take note of the network environment around the vehicle, if there are network limitations, such as in an underground carpark, this can cause a delay or failure to send an alert, or remote instructions may fail to execute successfully.
- › Obstacles or moving objects might interfere with the normal working of the sensor and could affect the promptness and accuracy of detection by the system.
- › This function might not accurately detect a very small creature.

Alarm types

Alarms consist of the following:

- › Hazard lights flashing and horn sounding.
- › Mobile APP notification push, mail push

Switching off the alarm

The alarm can be switched off by unlocking the car doors with the key or the intelligent entry system.

Vehicle equipment

Please note that this manual describes all standard equipment, country-specific equipment and special equipment for this series. Therefore, some equipment or functions described in this manual may not be installed in your vehicle or only available in certain markets. To learn more about specific configurations, please refer to sales documents or consult the dealer where you purchased the vehicle.

Emergency shut-off system

When the vehicle is being driven normally, the system will automatically shut down the power battery for the high-voltage system to reduce the risk of electrical shorting in the following circumstances.

- › If the vehicle suffers a strong impact and the airbag deploys.
- › If the vehicle powertrain system develops a serious fault.

If any of the above situations occur please immediately contact an authorised service centre as quickly as possible.

Vehicle equipment

Please note that this manual describes all standard equipment, country-specific equipment and special equipment for this series. Therefore, some equipment or functions described in this manual may not be installed in your vehicle or only available in certain markets. To learn more about specific configurations, please refer to sales documents or consult the dealer where you purchased the vehicle.

System description

The event data recorder (EDR) records data related to the vehicle's dynamic and safety systems in the event of a collision to help understand the operation of the vehicle system. However, the EDR may not record data because of the severity or type of collision.

i NOTICE

The EDR only records data in the event of a serious collision. The EDR does not record data during normal operation.

Data access

In addition to the vehicle manufacturer, other parties (such as law enforcement agencies) can access and read EDR data using a CANoe device to connect a laptop computer and the on-board diagnostic interface.

Equipment to read the data can be purchased from a CANoe software vendor.

The data recorded by the EDR and their purposes are as follows:

| Data item | Purpose |
|-------------------------------------|---|
| Brake status | Records the use of the brake pedal in the event of a collision. |
| Collision speed | Records the speed in the event of a collision. |
| Seat belt buckle status | Records the status of seat belts in the event of a collision. |
| Airbag system warning light status. | Records whether the airbag error warning light was on before a collision. |
| Forward acceleration | Records the acceleration of the vehicle in the event of a collision. |

Data disclosure

Data recorded by the EDR will not be disclosed to a third party except under the following circumstances:

- › The owner or lessee of the vehicle gives consent.
- › In compliance with official demands from local police, court or public authority for relevant legal case or in the interests of public security.

However, the EDR data will be used for the following where necessary:

- › Research and development of vehicle safety features.
- › Data disclosed to a third party for research and development purposes

shall not contain specific information about the vehicle owner and the vehicle.

Vehicle equipment

Please note that this manual describes all standard equipment, country-specific equipment and special equipment for this series. Therefore, some equipment or functions described in this manual may not be installed in your vehicle or only available in certain markets. To learn more about specific configurations, please refer to sales documents or consult the dealer where you purchased the vehicle.

Data privacy and protection

Related vehicle data

To ensure safe operation of the vehicle, the electronic control unit may process data collected by the sensors, data that are self-generated and data exchanged between these two sources.

Under normal circumstances, most of these data are collected temporarily and only transferred between vehicle systems. Only a small amount of data will be saved in the data accumulator for use as necessary for personalised settings.

The data accumulator on the vehicle is used to temporarily or permanently record the vehicle status, load on components, maintenance requirements and details of faults.

Depending on the vehicle equipment, these data may include:

- › Details of the vehicle status, such as

vehicle speed, wheel speed and lateral acceleration.

- › Environment conditions, such as temperature and rainfall.
- › The operational status of vehicle systems, such as fluid level, tyre pressures and battery condition.
- › Important system fault details, such as lights and brakes.
- › Reactions triggered by a vehicle system due to exceptional circumstances, such as air-bag inflation and an adjustment to the vehicle by a driving assistance system.
- › Other details of damage to the vehicle.

Under special circumstances the data accumulator may need to save data collected temporarily, such as when a vehicle fault is identified.

After a fault has been rectified, the details in the accumulator for the fault will be deleted, and collection of the latest details will continue without interruption.

NOTICE

When the vehicle is undergoing maintenance or servicing, the relevant data from the fault accumulator can be accessed by an authorised service centre.

Data read through the on-board vehicle diagnostic interface may assist with fault analysis, warranty service and quality improvements. It may be sent with the

vehicle identification number to the vehicle manufacturer as necessary to understand customer warranty requirements as well as to provide a basis for product recalls and determining responsibilities, etc.

WARNING

Only an authorised service centre can read the fault data accumulator using the on-board diagnostic interface. Do not attempt to read this data yourself. Improper use of the on-board diagnostic interface may cause damage to the vehicle or even an accident resulting in bodily injury.

System data

Data recorded by a vehicle system or by an external memory device connected to the vehicle.

- › Customising settings stores or modifies the data of some comfort and convenience functions, such as seat position, air-conditioning settings and side mirror positions.
- › Data transmitted to the vehicle's audio-visual system through external storage devices, such as broadcast multimedia data and Bluetooth device data.

NOTICE

You may choose whether or not to transfer these data to a third party.

Personal data

Information about the vehicle owner can be traced using the vehicle identification number or vehicle number plate. Therefore under certain circumstances data generated or processed by the electronic control unit relates to you personally, and private information about your driving behaviour, your address, your driving routes or your use of the vehicle can be found through these data.

Apart from functions and services required by law and regulations, such as emergency rescue, vehicle manufacturers may collect, process and use personal data only when legally permitted or with your consent.

Mobile phone interaction

Provided the vehicle has the necessary equipment, you can use a data cable to connect a mobile phone to the on-board USB port to activate mobile phone interaction. When you do so, the vehicle's audio visual system can output the pictures and sounds of the mobile phone, and at the same time can transmit other vehicle data, such as location, to the mobile phone. There will be no other interactions between the mobile phone and the vehicle, especially active access to vehicle data.

You can learn about other data processing processes, such as whether and which settings can be applied, by contacting the supplier of the appropriate

app. Specific details depend on the app and the mobile phone operating system.

Third party online services

If the vehicle has equipment that uses online services provided by a third party, the responsibility in the terms for data protection and privacy is taken by the third party.

Your rights with regard to data protection

According to relevant laws and regulations, if a vehicle manufacturer or third party stores your personal data, you can ask what data of yours are stored, the purpose of these data and from where the data were obtained.

You can access some data stored on the vehicle by contacting an authorised service centre.

Legal requirements for data disclosure

According to relevant laws and regulations, under special circumstances and when necessary, such as when investigating criminal activity, a vehicle manufacturer is obliged to release a certain subset of data stored in a vehicle in accordance with an official demand from local police, a court or a government department.

According to relevant laws and regulations, local police, courts or government departments have the right to access vehicle data on their own under special circumstances.

5

Emergency

| | |
|---|-----|
| Toolkit..... | 212 |
| Punctures or low tyre pressure | 213 |
| In case of an accident | 216 |
| Jump lead connection | 218 |
| Towing..... | 220 |
| Services and recovery | 224 |

Vehicle equipment

Please note that this manual describes all standard equipment, country-specific equipment and special equipment for this series. Therefore, some equipment or functions described in this manual may not be installed in your vehicle or only available in certain markets. To learn more about specific configurations, please refer to sales documents or consult the dealer where you purchased the vehicle.

Toolkit location

The vehicle document bag, reflective vest and wheel nut cover removal tool are in the front passenger-side glove box. The first aid kit and other vehicle tools are in the luggage compartment.

CAUTION

- › The driver must be familiar with the location of the tools and how to use them in case of emergencies.
- › After using a tool, be sure to secure it in the position specified. Placing tools elsewhere can cause accidents.
- › If your vehicle is equipped with a first aid kit, check the expiry dates of the medicine inside the first aid kit periodically, replacing them when necessary.

Vehicle equipment

Please note that this manual describes all standard equipment, country-specific equipment and special equipment for this series. Therefore, some equipment or functions described in this manual may not be installed in your vehicle or only available in certain markets. To learn more about specific configurations, please refer to sales documents or consult the dealer where you purchased the vehicle.

Air pump and tyre repair fluid

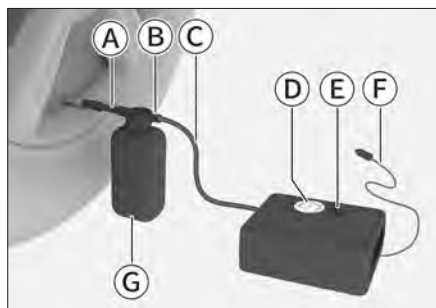

- Ⓐ Outlet pipe
- Ⓑ Air intake
- Ⓒ Inflation tube
- Ⓓ Pressure gauge
- Ⓔ Air pump switch
- Ⓕ Power cable
- Ⓖ Tyre repair fluid

If a tyre is punctured by a foreign object causing a leak, use the air pump and the tyre repair fluid for emergency repair.

i NOTICE

- › The air pump and the tyre repair fluid can only be used to repair sealed tyres with a puncture on the tread.
- › The ability of the tyre repair fluid to seal tyre walls is limited. If the tyre has large cracks, splits or similar damage, the tyre repair fluid cannot be used to repair the tyre.
- › The tyre repair fluid cannister must be replaced after use. You should go to an authorised service centre to have it replaced by a qualified professional.

⚠ WARNING

- › If the fluid has expired, replace and dispose of the expired fluid as hazardous waste.
- › Accidentally consuming tyre repair fluid is harmful to your health. Contact with skin can lead to an allergic reaction. If skin contact occurs, immediately wash the sealant from your skin with water or soapy water.
- › Tyre repair fluid should be kept out of the reach of children.

Emergency tyre repair

1. If repairing the tyres at a location with vehicles passing, place a warning triangle in an appropriate position and turn on the hazard lights. If the puncture is due to a nail or similar object, leave the object in the

tyre. This helps seal the puncture.

2. Ensure that the air pump switch is in the off state (0 position) and then take out the power cable and tubing.
3. Unscrew the cover of the tyre repair liquid air intake. Screw the inflation tube tightly onto the air intake of the tyre repair liquid, and screw the air outlet tube of the tyre repair liquid into the air valve of the tyre.
4. Plug the power cable into the 12-volt power supply socket and start the vehicle.
5. Switch the air pump to position I to start the air pump, and inflate the tyre to 240-250 kPa.

WARNING

Do not stand next to the tyre while operating the air pump. If the tyre develops a split or is uneven, the pump must be turned off immediately.

CAUTION

Do not operate the air pump for longer than 10 minutes, otherwise there is a risk of overheating.

NOTICE

If the tyre pressure achieved is less than 180 kPa, it indicates that the tyre is severely damaged, so do not continue. At this point, it is recommended that you contact an authorised service centre as quickly as possible.

6. Turn off the air pump, remove the power cable from the 12 volt power socket, and disconnect the tyre repair liquid from the air valve of the tyre.
7. Immediately (within 1 minute) drive at a speed of 20 to 60 km/h for about 5 km, so that the tyre repair fluid seals the tyre evenly.
8. Connect the pump and read the pressure value on the tyre pressure gauge.
 - › A tyre pressure of less than 130 kPa indicates that the tyre is not fully sealed. You cannot continue driving at this time, please contact an authorised service centre as quickly as possible.
 - › If the tyre pressure exceeds 130 kPa, the tyre should be inflated to the tyre pressure indicated on the tyre pressure sticker.
9. Turn off the air pump, disconnect the inflation tube and power cable, and fit the tyre air valve dust cover.

CAUTION

After the tyre is inflated, the tyre air valve dust cover must be fitted to avoid damage to the tyre air valve being caused by gravel and dust etc.

WARNING

After using the air pump and the tyre repair fluid to repair a tyre, do not

drive faster than 80 km/h or further than 200 kilometres. It is recommended that you repair or replace the damaged tyre as soon as possible, and that you notify the repair technicians that the tyre contains repair liquid.

Tyre inflation

If tyre pressure is too low, use the air pump to inflate the tyre.

1. Ensure that the air pump is turned off and take out the power cable and the inflation tube.
2. Screw the inflation tube into the tyre air valve.
3. Plug the power cable into the 12-volt power supply socket and start the vehicle.
4. Switch the air pump to position I to start inflation.

CAUTION

Do not operate the air pump for longer than 10 minutes, otherwise there is a risk of it overheating.

5. The tyres should be inflated to the tyre pressure indicated by the type pressure sticker.
6. Turn off the air pump, disconnect the inflation tube and power cable, and fit the tyre air valve dust cover.

In case of an accident

Vehicle equipment

Please note that this manual describes all standard equipment, country-specific equipment and special equipment for this series. Therefore, some equipment or functions described in this manual may not be installed in your vehicle or only available in certain markets. To learn more about specific configurations, please refer to sales documents or consult the dealer where you purchased the vehicle.

In case of a traffic accident

Use the following measures to warn other vehicles when you are forced to stop on the road due to a traffic accident or your vehicle breaks down:

- › Turn on the hazard warning lights.
- › Put on the reflective vest that came with the vehicle.
- › Place a warning triangle behind the vehicle in accordance with local traffic regulations.

In case of fire

If your vehicle emits heavy smoke or has a fire, immediately pull the vehicle off the road and park at a site away from other people. Turn off the power (ignition), evacuate passengers to quickly leave the vehicle and move far away. Where it is safe and possible to do so, do the following:

- › Based on the situation, call emergency personnel.

- › If you know that the fire is relatively small and not near the high-voltage system, you may try to put the fire out using the on-board fire extinguisher. If it is a large fire or the fire is near the power battery, you should quickly move far away to upwind of the vehicle and promptly notify the fire department. Because of the risk of electric shock, do not use water to extinguish the fire.
- › If someone inhales a large amount of the smoke, move him or her away and seek medical attention as soon as possible.

WARNING

- › Lithium batteries burn at a very high temperature and release harmful gases. Keep away from a burning vehicle.
- › Do not touch any liquid that has leaked out of the power battery. If any liquid from the batteries comes in contact with your skin or eyes, flush immediately with water and seek medical attention to avoid further harm.
- › If firefighters use water to extinguish the fire, do not touch the water in order to avoid electric shock.
- › Lithium batteries may reignite even if no flame is visible. Therefore, do not quickly return to the vehicle. Look carefully for any evidence of fire such

as smoke or flames.

Jump lead connection

Vehicle equipment

Please note that this manual describes all standard equipment, country-specific equipment and special equipment for this series. Therefore, some equipment or functions described in this manual may not be installed in your vehicle or only available in certain markets. To learn more about specific configurations, please refer to sales documents or consult the dealer where you purchased the vehicle.

Signs of a drained battery

- › Unable to start the vehicle.
- › Front lighting is abnormally dim.
- › The horn will not sound, or the sound is weak.

Starting with jump leads

If the vehicle cannot be started due to the 12V battery being flat, you can use jump leads to connect to the auxiliary battery of another vehicle in order to start the vehicle.

The cross-sectional area of the jump leads must be at least 25 mm².

⚠ CAUTION

- › Not all vehicle batteries are suitable. Only use 12V batteries to start the vehicle using jump leads.
- › You cannot push or tow the vehicle to start it.

1. Follow the order below to connect

jump leads.

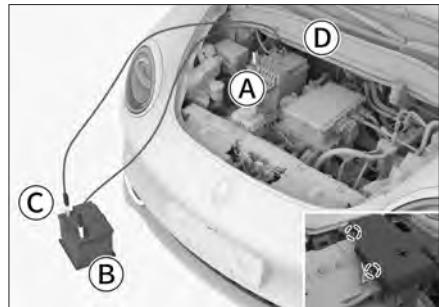

180532CDB07C

- Ⓐ Positive pole of the battery in the vehicle with a flat battery ⊕
(To connect to this pole, you must open the protective cover.)

Ⓑ Positive pole of the battery in the rescue vehicle ⊕

Ⓒ Negative pole of the battery in the rescue vehicle ⊖

Ⓓ Negative pole of the battery in the vehicle with a flat battery ⊖
2. How to charge the battery.
Start the rescue vehicle and run it for about 5 minutes. This can temporarily charge the battery of the vehicle with the flat battery.
3. Start the vehicle with the flat battery.
If you still cannot start the vehicle, verify that the connection has been made properly before continuing to charge the battery.
4. Remove the jump leads.
Once the vehicle has started, remove the jump leads in the reverse order to that in which they were connected.

WARNING

- › In the process of charging or starting with jump leads, there may be an emission of gas from the battery. At this time there is a risk of explosion. Always keep batteries away from sparks, open flames and flammable items.
- › Battery fluid is corrosive and can cause serious injury to eyes and skin. In case of accidental contact, please immediately rinse with a large quantity of water, and seek medical attention immediately.
- › When connecting or removing a jump lead, ensure the cable does not become wrapped around fans, belts, and so on.
- › Ensure that the power cables are connected correctly and keep the leads apart to avoid the positive and negative poles coming into contact.

CAUTION

If the battery is often flat, please go to an authorised service centre for inspection.

Towing

Vehicle equipment

Please note that this manual describes all standard equipment, country-specific equipment and special equipment for this series. Therefore, some equipment or functions described in this manual may not be installed in your vehicle or only available in certain markets. To learn more about specific configurations, please refer to sales documents or consult the dealer where you purchased the vehicle.

Using a specialised vehicle for transport

This vehicle should not be towed with a tow bar with the wheels on the ground. In the event of a breakdown, use a flatbed transport vehicle. Therefore, in the case of a breakdown, contact an authorised service centre.

⚠ WARNING

- › You must comply with the requirements of local laws and regulations concerning towing vehicles.
- › The vehicle should only be transported on a flatbed transporter. It should not be transported with wheels on the ground, otherwise, the vehicle could be seriously damaged.
- › Do not tow your vehicle with a trailer hook, towrope or chain.

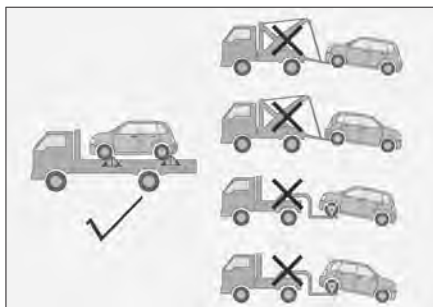

Securely lock the vehicle in place when transporting it.

Pushing the vehicle

⚠ WARNING

Do not push the vehicle to cruise downhill for coasting.

The vehicle may be pushed up to a maximum distance of 50 metres and a maximum speed of 5 km/h if it needs to be moved out of a hazardous area.

When pushing the vehicle, the following conditions should be met:

1. Start the vehicle and switch to N gear.
If the vehicle cannot be started, switch the vehicle power supply mode to the ON mode, and switch to N gear.
2. Turn on the hazard warning light and release the parking brake to push the vehicle.

If the vehicle gets stuck or high-centred

Drive cautiously in snow, mud and sand

because it is easy to get your vehicle stuck or high-centred in such conditions.

Try the following if the vehicle gets stuck:

1. Turn the vehicle off and make sure that you have set the parking brake.
2. Clear the mud, snow or sand around the tyre that is stuck.
3. Use a wood block, stone or other material to improve the tyre's grip.
4. Restart the vehicle and use an appropriate drive mode.
5. Release the parking brake and accelerate carefully to free the vehicle.

⚠ WARNING

Note the following when stuck in a hole:

- › Ensure that the surrounding area is open and unobstructed to avoid hitting other vehicles, objects or people.
- › In the instant when the vehicle gets free from the hole, it will abruptly jump forward or backward, so show extra caution.

If it is not possible to free the vehicle, contact a professional rescue or an authorised service centre. Do not allow an unqualified person to drag the vehicle out.

⚠ WARNING

Observe the following precautions when freeing the vehicle to avoid

damaging the vehicle or endangering personal safety.

1. When using a tow hook, tie a cable dampener in the middle of the tow rope to prevent the tow hook or rope from breaking and recoiling, which could damage the vehicle and even endanger personal safety.
2. Do not tow from a side or vertical angle. The best angle for the tow hook is within 5° up to down and 25° left to right.
3. Do not use sudden forceful jerking to pull the vehicle. The initial tow speed should not exceed 5 km/h. Start slowly until the tow rope is taut.
4. When using the tow hook, the towing force must not exceed the weight of the vehicle.

Tow rope

Tow ropes should be elastic to protect the vehicle. We recommend a rope or cable made of synthetic fibre or similar elastic material.

Only attach the tow rope to the designated tow hook or towing ring.

Be careful not to damage the vehicle body when attaching the tow rope. The distance between the towing and towed vehicles should be between 4 and 10 metres.

Tie a marking flag to the middle of the

tow rope. When possible, use reflective material on the tow rope when towing at night to increase visibility.

⚠ CAUTION

- › A tow rope can be separately purchased.
- › To avoid damaging the bumper, do not use a steel cable for towing.

Towing hook

Front towing hook

1. Insert a flat-headed screwdriver wrapped in a cloth into the notch of the towing hook cover plate to pry off the cover plate.

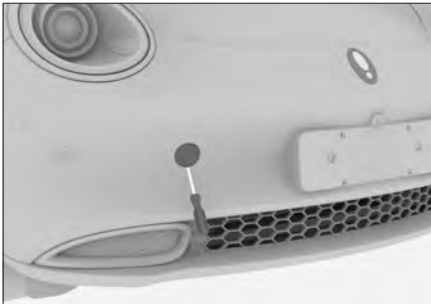

1A96A1B0D897

2. Screw the towing hook into the hole and tighten it clockwise to ensure that it is installed securely.



267EB8B91FDE

Rear towing hook

1. Insert a flat-headed screwdriver wrapped in a cloth into the notch of the towing hook cover plate to pry off the cover plate.



8A5BD41B653A

2. Screw the towing hook into the hole and tighten it clockwise to ensure that it is installed securely.



736C19FE6145

Towing other broken down vehicles

1. When towing, turn on the hazard warning lights and follow local regulations.
2. Start slowly until the tow rope tightens, then accelerate carefully.

⚠ CAUTION

- › Do not tow a vehicle that is heavier than this vehicle to avoid potential damage to this vehicle.
- › Avoid sudden starts or jerky movements to prevent excessive tensile force acting on the towing hook and the tow rope.
- › Do not use the tow rope to tow over a long distance downhill.
- › Do not tow the vehicle backwards.

Vehicle equipment

Please note that this manual describes all standard equipment, country-specific equipment and special equipment for this series. Therefore, some equipment or functions described in this manual may not be installed in your vehicle or only available in certain markets. To learn more about specific configurations, please refer to sales documents or consult the dealer where you purchased the vehicle.

Function introduction

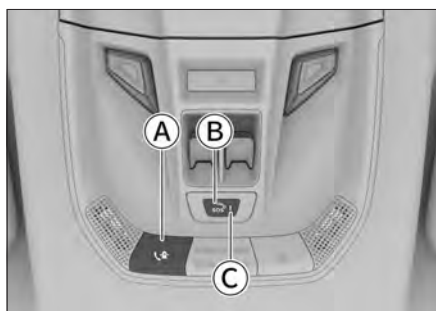

- (A) Person-to-person service button (📞)
- (B) Emergency rescue button (sos)
- (C) Emergency call light

Person-to-person service

Press and hold the 📞 the person-to-person service button to trigger a person-to-person service call.

With person-to-person service you can search for a destination or a point of interest, make an information enquiry, book a service, make an emergency call enquiry and arrange roadside recovery,

etc.

Press and hold 📞 the person-to-person service button to end a person-to-person service call.

Emergency rescue

Press sos emergency rescue button for 0.5- 4 seconds. This will trigger an emergency rescue call. To cancel the call, press again in 4 seconds sos button, otherwise you cannot cancel. Once a call is established, it can only be cancelled by the PSAP (Rescue central).

A collision (when the airbag deploys) automatically triggers an emergency rescue call and you cannot manually end the emergency rescue call while it is in progress.

When an emergency rescue call is triggered, relevant data, such as the location of the vehicle, is automatically sent to the rescue service (▷ Page 207), and the rescue centre will respond to the vehicle rescue request at the first opportunity.

i NOTICE

Avoid making unnecessary or frequent emergency rescue calls.

! CAUTION

Many factors, including but not being limited to the following circumstances, might affect emergency rescue call functionality and could prevent it from being used:

- › If the emergency call system is faulty or damaged it will not be possible to trigger emergency calls.
- › If the audio device is damaged, or wiring connecting the emergency call system or the audio device is damaged or disconnected, it will not be possible to make normal emergency calls to customer services.
- › If in a minor collision or abnormal situation the airbags do not deploy, a rescue call will not automatically be triggered but can be initiated manually or the emergency call made in some other manner.
- › If the emergency button is damaged it will not be possible to manually trigger an emergency call.
- › If there is a bad mobile signal, or there is interference, or the signal has been blocked, it will not be possible to trigger an emergency rescue call.
- › If the GPS device is damaged or you are in an area with a weak signal, (such as in an underground carpark, a tunnel, or in mountainous areas) it may not be possible to locate the vehicle.
- › If the vehicle loses power it might not be able to trigger an emergency rescue call.
- › You may not be able to reach emergency rescue services due to factors such as riots, fires, flooding, storms,

explosions, war, government action, judicial orders, the social environment and force majeure.

- › If there are viruses, Trojans, or other malware in software you may have installed or downloaded from other websites, the security of your device and data may be compromised resulting in your being unable to access emergency services.
- › Other factors could also cause you to be unable to make emergency rescue calls.

Emergency call light

| Light status | Status description |
|-------------------|---|
| Off | Normal |
| Solid green light | Emergency call system is connected |
| Flashing green | Emergency call ended |
| Flashing red | Emergency call system did not connect within three minutes |
| Slow blinking red | Emergency call system has detected the backup battery charge is low |
| Solid red light | Emergency call system detected a persistent fault |

WARNING

Do not modify the emergency call system.

i NOTICE

For everyday use please follow these recommendations:

- › Regularly check that the emergency call system is working properly, and the emergency call light is off, which means that the system is normal. If there is a fault, please go to a service station as soon as possible to have it inspected and repaired.
- › We recommend replacing the battery inside the emergency call device at least every 3 years.

If there is a warning on the instruments that the emergency call system backup battery needs replacing, please go to a service station as soon as possible to replace the battery.

6

Maintenance

| | |
|---|-----|
| The importance of vehicle care | 228 |
| Engine compartment | 229 |
| Safety stickers and labels | 232 |
| Replacing components | 234 |
| Vehicle care | 238 |
| Environmental information. | 246 |

The importance of vehicle care

Maintaining your vehicle is like a health check and reduces later repairs

Each component on the vehicle is subject to unavoidable wear during vehicle use. Regular inspection, care and maintenance allow you to drive your vehicle with peace of mind, and they maintain and restore your vehicle's performance.

Maintaining your vehicle allows you to drive with greater peace of mind

During the maintenance service, necessary preventive measures can be carried out according to the use of parts and components to prevent problems before they occur, so that you can safely drive the vehicle till next maintenance service.

Extend the service life of the vehicle and reduce the cost of using the vehicle

Brake linings, tyres and other components cannot be used forever. As they perform their function, they gradually wear out. Using parts past their wear limit increases the risk of a vehicle breakdown and a traffic accident. This why it is necessary to have regular maintenance service.

Vehicle equipment

Please note that this manual describes all standard equipment, country-specific equipment and special equipment for this series. Therefore, some equipment or functions described in this manual may not be installed in your vehicle or only available in certain markets. To learn more about specific configurations, please refer to sales documents or consult the dealer where you purchased the vehicle.

Safety notice

⚠ WARNING

- › The engine compartment is a hazardous environment, take particular care when working on it!
- › To avoid injury, do not touch high-voltage parts, power cables, or connections.
- › Do not touch the radiator fan while the drive motor is still warm, as the fan may suddenly switch on. Items such as long scarves, ties or clothing can become entangled with moving parts, causing serious injury.
- › Do not carry out inspection work when the vehicle is running, because rotating parts (i.e. the radiator fan), high-voltage components and the powertrain system can pose a risk.
- › When checking or filling oil or fluids, please do the following to prevent burns, fire or electric shock:

- 1) Switch the vehicle power supply mode to OFF.
 - 2) Apply the parking brake.
 - 3) Allow the drive motors to fully cool.
 - 4) Keep children away from the engine compartment.
 - 5) Keep water away from the engine compartment.
- › When carrying out electrical installation, please follow the following precautions, or you may cause a fire:
- 1) Disconnect the negative pole of the battery.
 - 2) Smoking is prohibited.
 - 3) Do not carry out work near any naked flame.

⚠ CAUTION

When adding oil or fluids do not confuse these, otherwise you could cause serious faults and damage to vehicle parts.

Location of oil and fluids

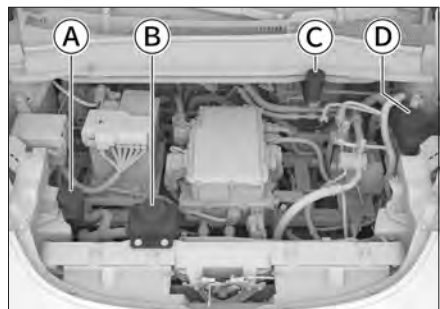

OC0BB9369F22

- Ⓐ Windscreen washer fluid tank

- Ⓑ Powertrain system coolant expansion tank
- Ⓒ Brake fluid reservoir
- Ⓓ Heating system coolant expansion tank

Brake fluid

Check

The level in the fluid reservoir should be checked regularly.

Check that the level in the fluid reservoir is between the lower and upper limit marks.

If the brake fluid level is below the lower mark, you should add brake fluid to raise the level to between the lower and upper marks and check the braking system for any leaks.

Add

Unscrew the fluid reservoir cap and pour the brake fluid in slowly to avoid spillage. If spilt, it should be cleaned up immediately. Failure to do so could damage components in the engine compartment.

Be sure to use the type of brake fluid specified.

WARNING

- › If there is not enough brake fluid, the brakes could become ineffective, which can lead to an accident.
- › Brake fluid is harmful to health and is corrosive. In case of accidental contact, flush immediately with a large

amount of fresh water. If ingested, seek medical attention immediately.

Coolant

Check

The liquid level in the expansion tank should be checked regularly.

Check that the level of fluid in the expansion tank is between the lower and upper limit marks.

If the coolant level is below the lower mark, you should add coolant to raise the level to between the lower and upper marks and check the cooling system for any leaks.

Add

Wait until the engine compartment has cooled down, then slowly open the cap to reduce the pressure.

If coolant is spilt, wash with clean water to prevent damage to components or painted surfaces.

Be sure to use the type of coolant specified.

WARNING

- › Ethylene glycol lowers the freezing point of the coolant. Do not dispose of coolant carelessly, as this will lead to water contamination.
- › Do not remove the expansion tank cap when the engine compartment is hot. The cooling system may be under pressure and hot coolant may

spray out if opened, leading to burns or other injuries.

- › To replace the coolant, please contact an authorised service centre.

Windscreen washer fluid

Add

Remove the fluid reservoir cap and pour in the screen wash slowly to prevent spillage. If any is spilt, the spillage should be cleaned up immediately.

Good quality screen wash should be used to improve the ability to remove dirt and prevent freezing in cold weather.

⚠ WARNING

Do not refill the screen wash when the engine compartment is hot or motors are running. Since screen wash contains alcohol, there is a risk of fire if spilt on parts within the engine compartment.

⚠ CAUTION

Please do not add liquids such as soapy water in place of screen wash, as this could damage the paintwork.

Active intake grille

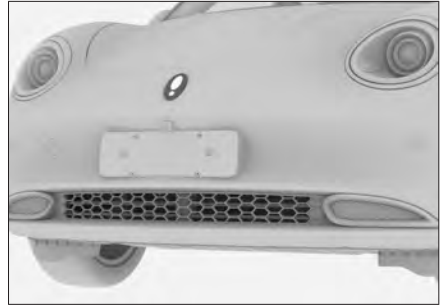

BA76B8D19E35

Once the vehicle's heat dissipation requirements have been met, the active intake grille takes control of the angle of the grill blades to reduce drag when driving fast. This reduces energy consumption and improves passenger and driver comfort.

While driving, if it detects that the cooling or A/C systems need to turn on, the grille blades open automatically.

Regularly clean the intake grille.

Battery

This vehicle uses a maintenance-free battery.

If the battery charge is low, it needs to be charged immediately or it may need to be replaced. Please go to an authorised service centre to replace the battery.

Safety stickers and labels

Vehicle equipment

Please note that this manual describes all standard equipment, country-specific equipment and special equipment for this series. Therefore, some equipment or functions described in this manual may not be installed in your vehicle or only available in certain markets. To learn more about specific configurations, please refer to sales documents or consult the dealer where you purchased the vehicle.

Engine compartment warn- ing sticker

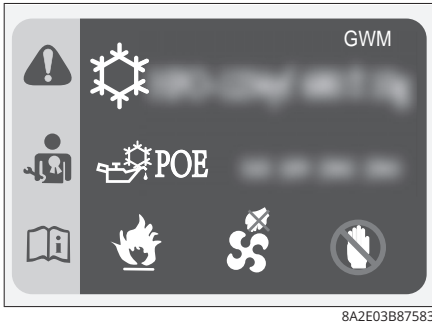

This sticker is located above the front bumper, as a reminder:

- › The A/C refrigerant type and the amount to be added.
- › The cooling fan may start at any time, so please do not put your hand inside the protective cover over the fan. If you do this, and the fan starts unexpectedly, you can suffer a serious injury.

Warm air system overflow tank warning label



This label is located on the warm air overflow tank, and is to remind you not to open the overflow tank cover while the warm air system is on or has not cooled completely. Otherwise, hot liquid and steam expelled under pressure could cause burns.

Powertrain system overflow tank warning label



This label is located on the powertrain system coolant overflow tank; its purpose is to remind you not to open the overflow tank cover when the drive motor is too hot. Otherwise, hot liquid and steam expelled under pressure could

cause burns.

Battery warning symbol



This symbol is on the battery. It reminds you of the following before installing, removing or inspecting the battery:

- › Children should be kept away from batteries.
- › The battery may produce flammable gas during use or while charging. Keep away from high-temperature heat sources and open flames, otherwise this may cause a fire or explosion.
- › The battery contains a highly corrosive liquid.
- › Wear protective goggles and other necessary protective measures during operation.

Replacing components

Vehicle equipment

Please note that this manual describes all standard equipment, country-specific equipment and special equipment for this series. Therefore, some equipment or functions described in this manual may not be installed in your vehicle or only available in certain markets. To learn more about specific configurations, please refer to sales documents or consult the dealer where you purchased the vehicle.

Fuses

If an electrical component is not working, a fuse may have blown. If this occurs, it is recommended to check as follows and replace the fuse if necessary:

1. Switch off all electrical components.
2. Switch the power supply to the OFF mode and apply the parking brake. Disconnect the negative pole of the battery.
3. The fuses are located in the following positions:

> in the engine compartment fuse box



49EA64E6EFFF

Open the fuse box by pushing down

on the catch while pulling the fuse box cover upwards.

> in the dashboard near the steering wheel



479336D6AE54

Remove the cover and you will see them.

⚠ CAUTION

- > Ensure water or other liquids do not penetrate the interior of the fuse boxes, otherwise they may damage the electrical components.
- > When fitting a fuse box cover, ensure that it is seated properly on the fuse box. Otherwise, ingress of moisture or dirt can affect the fuses.

- Use the fuse puller that comes with the vehicle to pull out the fuses. Find the fuse corresponding to the faulty electronic device by using the fuses diagram and inspect them.

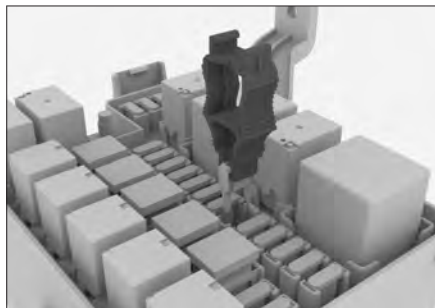

518A7B6272F2

⚠ CAUTION

- ▶ The fuse puller and the backup fuses are found in the fuse box cover in the engine compartment.
- ▶ There are fuse diagrams on the engine compartment fuse box cover and dashboard fuse box cover. Using the diagrams, which will allow you to determine the relationships between each fuse and the electronic device it protects.
- ▶ Since there may be more than one fuse causing the fault, it is necessary to examine all of the fuses that could be at fault before it can be eliminated. If you are still unable to eliminate the fault, please contact an authorised service centre to have the fault resolved.

- Look at the wire inside the fuse, if it has blown, replace it with a backup

fuse of the same amp rating.

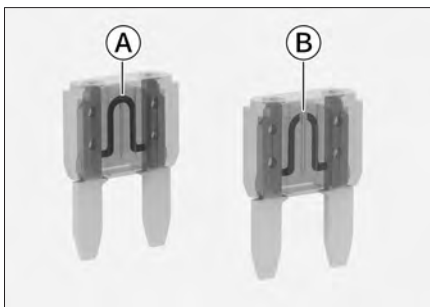

6DC672024A26

- Ⓐ Normal fuse
- Ⓑ Blown fuse

⚠ WARNING

Do not attempt to repair the blown fuse or replace it with one of a different colour or rating, overloaded wiring could catch fire.

- Check that the electronic device is now operating normally.

⚠ CAUTION

If a backup fuse with the same amperage blows after a short time or the electronic device does not return to normal operation, this indicates that the vehicle may have a serious electrical system fault. At this time, you should immediately get in touch with an authorised service centre.

Wiper blades

Front wiper blade replacement

Inspect the wiper blades regularly, and replace the wiper blades if:

- › The wiper blade is cracked or has stiffened.
- › The wiper blades leave streaks or do not clean properly when in use.

⚠ CAUTION

When lifting the wipers, do not pull the wiper blade directly to avoid it becoming misshapen or damaged.

1. Switch the power supply mode to OFF and pull the wiper control combination switch upward for approximately 3 seconds. The wipers will automatically reach the maintenance position, as shown in the diagram.



3851315BD0BB

2. Raise the wiper arm up off the windshield.

⚠ CAUTION

- › If it is necessary to lift the wiper, make sure it has reached the maintenance position. Otherwise, the wiper will be damaged.
- › Do not open the bonnet while the wiper is being lifted. Otherwise, the bonnet and the wiper may be

damaged.

3. Rotate the wiper blade in the direction of the arrow in the diagram until it reaches its greatest angle to the plastic joint.



B26AF2BA18B2

4. Remove the wiper blade from the wiper arm.



97E717B52765

Ⓐ Wiper blades

Ⓑ Flexible fastener

While pressing the flexible fastener, pull the wiper blade in the direction of the arrow in the diagram until it disengages from the wiper arm.

⚠ CAUTION

If a wiper blade is not fitted, do not place the wiper arm directly on the

windscreen, this will damage the glass.

5. Fit a new wiper blade and place the wiper back on the windscreen.
6. Reset the wiper to its original state. Change the power supply mode to ON. The wiper will automatically reset to its original state.

Bulbs

When the new vehicle leaves the factory, the front light assembly has already been calibrated. If you often carry heavy loads in your vehicle, the front light assembly may need to be realigned. Please go to an authorised service centre to calibrate the front light assembly.

Checking light bulbs

You should check regularly that the external lights are working. A burned-out bulb will reduce the vehicle's visibility and the ability to signal warnings to other drivers, seriously affecting the vehicle's safety.

Bulb replacement

Light bulbs should be replaced by specialist staff.

Under normal circumstances you should not replace a damaged light bulb yourself, you should let specialist staff do it. The main reasons are: Before replacing a bulb other vehicle parts must be removed, especially those bulbs that can only be accessed from within the engine compartment. Therefore, it is recommended that you go to an authorised

service centre to replace a bulb.

WARNING

- › Bulbs are under pressure and may explode when replaced. There is a risk of injury.
- › If the vehicle is fitted with xenon lightbulbs, do not turn on the lights when replacing the bulb. Otherwise, a high voltage shock could cause serious injury.
- › Do not customise the external lights or indicator assemblies.
- › Do not fit external lights or indicator assemblies that are not compliant with the compulsory standards.

Concerning condensation in lights

When driving in the rain or washing the vehicle, condensation may form on the lens of the light. This is caused by the temperature difference between the air inside the light and that outside. It is the same as the condensation caused on the vehicle windows on rainy days, and does not affect the functioning of the lights. However, if there are large water droplets or a build-up of water within the lights, please contact an authorised service centre to carry out repairs.

CAUTION

Do not use chemical solvents or strong detergents to clean the lights, as these can damage them.

Vehicle equipment

Please note that this manual describes all standard equipment, country-specific equipment and special equipment for this series. Therefore, some equipment or functions described in this manual may not be installed in your vehicle or only available in certain markets. To learn more about specific configurations, please refer to sales documents or consult the dealer where you purchased the vehicle.

Tyre care

To ensure the safe operation of the vehicle, the tyre type and size must be suitable for your vehicle model. Tyre treads must be in good condition, and the tyres should be inflated to the correct pressure.

WARNING

- › Do not use tyres that are overly worn, damaged, under-inflated or over-inflated, otherwise there is risk of an accident that may cause injury.
- › Follow all instructions in this manual about inflating and caring for tyres.
- › Burning tyres release harmful gases. Take them to an authorised service centre for disposal.

Inspecting tyres

Every time you check the tyre pressures, also check for surface damage and wear and whether there is any foreign body

that has punctured the tyre.

If you find any of the following, replace the tyre as soon as possible:

- › Damage or protrusion on the tyre surface or side wall.
- › Excessive tyre wear.

Tyre pressure

Keeping tyres properly inflated provides the best combination of handling, tread durability and driving comfort.

An under-inflated tyre will wear unevenly and affect handling and driving efficiency. It is more likely to suffer air leakage due to overheating.

Overinflated tyres are less comfortable for passengers and prone to damage from uneven road surfaces and uneven wear.

We recommend regular inspection of tyre pressures, including the spare tyre (if included).

Measure the tyre pressures when the tyres are cool. Tyre pressure measurements are most accurate when you have parked the vehicle for three or more hours or have driven less than 1.5 km. If you check the tyre pressures when the tyres are warm (after driving several kilometres), the pressure reading will be 30 to 40 kPa higher than when cool. This is normal. Do not let out air to get the reading to match the specification because this will result in insufficient tyre pressure.

i NOTICE

Even tyres that are in good condition may lose 10 to 20 kPa of pressure per month, so be sure to check the pressure regularly.

Tyre wear

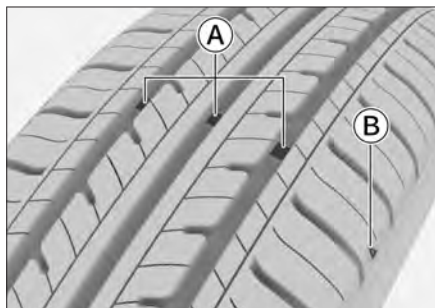

- Ⓐ Wear marks
- Ⓑ Wear mark position symbol

i NOTICE

The wear mark location symbol here is for visual reference only. Be sure to check your actual vehicle.

When tyre wear reaches the limit, replace the tyres as soon as possible. Continuing to drive on a tyre with shallow tread or exposed wear marks will lead to longer braking distances, loss of steering effectiveness, tyre rupture and other situations, which can easily cause an accident.

We recommend you regularly check the tyre wear. If you notice uneven tyre wear or you feel continuous vibration while driving, go to the authorised service

centre to check the tyres.

When new tyres are installed, they must be dynamically balanced to increase driving comfort and extend the life of the tyres.

Tyre rotation

We recommend regularly rotating the rear tyres to the front and the front tyres to the rear to extend the life of the tyres and ensure even tyre wear.

A professional should perform the tyre rotation. We recommend visiting an authorised service centre to carry out the rotation.

Wheel balancing

Unbalanced wheel can affect vehicle handling and the life of the tyres. Wheels may get out of balance even when used correctly. Therefore, adjust the wheel balance according to the wheel dynamic balance parameters.

Avoiding flat spots

If a vehicle is parked for a long time in a warm climate, the points where the tyres touch the ground will slightly deform. These normal deformities are called "flat spots". However, these deformations cause vibrations in the body and steering wheel when driving. As you continue to drive, the tyres will heat up and return to their original shape, and the vibrations will gradually smooth out. When your vehicle will be parked for a long time, use one of the methods

below to minimise flat spots:

- › Over-inflate the tyres (up to about 300 kPa). This pressure is not suitable for driving, so the tyre pressure must be lowered to the recommended level before driving.
- › Move the vehicle at least once every 30 days (ideally every 15 days). Make sure that the wheel rotates at least 90° from the point where the pressure was previously applied.

Sunroof care

Schedule for regular care

Driving conditions and how often you use the sunroof will determine its schedule for regular care.

We recommend more frequent care when driving in areas with a lot of sand or dust or in rainy areas.

CAUTION

If the sunroof is not appropriately cared for, it may begin to leak or make abnormal sounds. Determine the frequency of care based on how you use the sunroof. For example, you should increase the frequency if you drive in areas that have substantial dust or sandstorms and during seasons when you use the sunroof more often.

Routine care procedures

Dirt and other foreign objects may accumulate in the sunroof's seals, mechanical parts or guide tracks, which may

result in abnormal sounds and malfunction. It may also obstruct the sunroof's drainage mechanism. Regularly open the sunroof, clear any dirt or foreign objects, and use a clean rag and water to wipe the sunroof's seals. Regularly lubricate the sunroof's mechanical parts.

Open the sunroof and inspect whether it gets jammed during operation. If so, take your vehicle to an authorised service centre for service as soon as possible.

CAUTION

- › If your sunroof stops working, take your vehicle to an authorised service centre for service.
- › If the sunroof ices up, do not force it open because this may damage the motor and seals. Open the sunroof only when the temperature in the vehicle has increased to the point that the seals and roof have thawed.
- › After washing your vehicle, if the temperature is below freezing, open the sunroof and use a dry rag to wipe the sunroof's seals before driving the vehicle.
- › Be sure to fully close the sunroof before washing the vehicle, and do not aim the water spray directly at the sunroof's seals. The high-pressure water column may warp the seals and allow water into the cabin and damage the seals.

- › When driving on extremely bumpy roads or rugged terrain, do not leave the sunroof fully open for a long time, otherwise the vibrations may damage the sunroof's internal parts.
- › In the rainy season, inspect the sunroof's seals more frequently and promptly wipe off any sand or dirt found to ensure a good seal.

Exterior maintenance

Washing the car

Regular washing helps protect the vehicle's bodywork. Dust and grit can scratch the paintwork, and leaves and bird droppings can damage the finish.

You should wash the vehicle in the shade, not in direct sunlight. If the vehicle has been in the sun for a long time, drive it to a shaded area and wait for the body surface to cool down before washing.

How to wash

1. Check the body for leaves, bird droppings, dirt, etc.
Remove this dirt with a cloth or cleaning fluid and immediately wash with water to avoid damaging the finish.
2. Wash the vehicle thoroughly with water to remove loose dirt and dust.
Wash the vehicle with water and shampoo using a soft brush, foam or soft cloth.
3. Mix car shampoo in a bucket of

water, and wash downwards starting from the top of the vehicle.

4. After washing and rinsing the entire body, dry off with a special leather or soft towel. Do not air-dry naturally, as this can cause the bodywork to lose its lustre or can form water stains.

CAUTION

- › Chemical solvents and strong detergents can damage the paintwork and metallic and plastic parts.
- › After washing the vehicle or driving on flooded roads, gently press the brake pedal to ensure the brakes are working normally.
- › When washing the vehicle in winter, do not get water in the keyholes or door frames, etc. to avoid the locks or door seals freezing.

Waxing

Waxing is beneficial to the protection and maintenance of the vehicle. To ensure the effectiveness of the wax, the vehicle must be thoroughly washed before waxing.

There are currently many kinds of vehicle wax on the market, each with different characteristics, so you need to be careful in making the right choice, as the wrong choice not only fails to protect the vehicle's body, but can also affect the colour of the paintwork.

You need to give thought to the

properties of the wax, the age of the car, its colour and the environment in which you drive etc. If unsure, you can ask an authorised service centre or other expert.

Touching up paintwork

You should regularly check the bodywork for chips or scratches. If there are any, they should be repaired immediately to prevent rusting.

Touching up should only be done for minor chips or scratches, larger paint repairs should be carried out by experts.

Checking for leaks

Park the vehicle on a flat road surface and after a period of time check under the vehicle for leaking fuel, engine oil, or other fluids. If there is an obvious leak, please contact an authorised service centre to carry out repairs.

Interior care

WARNING

Cleaning agents may contain harmful substances that could cause injury. Consider opening the vehicle's doors or windows when cleaning the interior. Use only cleaning agents that are made for vehicle cleaning and following the instructions on the package.

NOTICE

› When cleaning the interior of the vehicle, DO NOT allow water or other

liquid to flow directly into the instrument panel crevices, floor or the nearby electronic device component. Failure to do so may result in water intake leading to abnormal functions.

› Do not wash the floor of the vehicle with water to avoid body corrosion.

Carpets

Regularly clean carpets with a vacuum cleaner. Allowing dirt to remain on carpets will increase wear on them.

Regularly washing carpets with detergent will keep them in better condition. Use a foaming detergent to clean carpets. Keep carpets as dry as possible by not adding water to the foaming detergent.

Fabric

Regularly use a vacuum cleaner to remove dirt from fabric.

For general cleaning, use a clean, soft cloth moistened with warm mild soapy water. Avoid watermarks by wiping with another dampened clean cloth and then allow to air dry.

Use a fabric cleaner to remove stubborn stains. Follow the instructions for using the cleaner.

Leather

Regularly use a vacuum cleaner to remove dirt, especially from creases and seams.

Clean the leather with a soft cloth

dampened with water, and then buff with another soft dry cloth. Use a leather cleaner for deeper cleaning.

Wipe off the leather cleaner with a soft dry cloth as soon as possible. Do not leave a cloth soaked in leather detergents on any part of the interior for a long time. Some leather cleaners may cause the resin or fibres of the interior fabric to discolour or become brittle.

Rubber components

Exposure to the environment may cause the surface of rubber parts to become soiled and lose their finish. Rubber parts should be cleaned regularly with rubber conditioner, especially worn rubber components.

In order to avoid damage and to reduce noise, do not use cleaning agents that contain silicone for routine maintenance of rubber seals. Use only water or a suitable conditioner to clean.

Plastic components

i NOTICE

Liquids containing alcohol or solvents (such as nitro thinner, cooling system cleaner, lighter fluid and perfume and cosmetics) can damage the surface of plastic components. Clean with a soft microfibre cloth slightly moistened with water.

Plastic components include, but are not limited to, the following: Artificial leather

surfaces, roof linings, headlight covers, vents and interior painted parts.

Windows

Clean the inside and outside of the windows with glass cleaner and dry all glass and plastic surfaces with a soft cloth or paper towel.

⚠ CAUTION

If the rear window has a heating wire, excessive wiping may cause it to move or break. Therefore, wipe lightly in the direction of the heating wire.

Seat belts

1. Use mild soapy warm water to clean soiled seat belts. Do not use bleach, dyes or cleaning solvents, which may reduce the durability of seat belts.
Allow seat belts to air dry before driving.
2. Too much dust accumulated inside the seat belt's guide loop will cause the seat belt to retract more slowly. Scrub the inner side of the guide loop with mild warm soapy water.

Anti-corrosion measures

Factors affecting the rate of corrosion

- › The accumulation of dirt, sand, ice and snow in the lower part of the vehicle body accelerate corrosion.
- › Damage to the coating or other protective layer caused by impacts from

sand or stones or minor accidents accelerates corrosion.

- › Driving in areas where the relative humidity is high or where the temperature remains above freezing point accelerates corrosion.
- › Pollution, salt in the air in coastal areas, and excess salt used on roads accelerate the corrosion of paint.
- › Higher temperatures accelerate the corrosion of poorly ventilated parts.

How to prevent corrosion

- › Regularly clean the vehicle with clean cold water and neutral vehicle detergent.
- › Regularly check whether the paint surface has damage and make necessary repairs as soon as possible.
- › Regularly check whether there is sand, dirt, snow or other material caked on the lower part of the vehicle body. If so, wash it off with water as soon as possible.
- › Keep the door drainage holes open to avoid accumulation of water.
- › Clean off insects, asphalt, cement and other similar material as soon as possible.
- › If you often drive on roads that have high concentrations of salt, such as to melt snow, in saline-alkali areas, and near the coast, wash off any material caked to the bottom of the car at least monthly.

- › If you often drive on sand or gravel roads, consider installing mudguards behind the wheels.

Long term vehicle storage

Parking should not only protect the car, but also allow easy access. If possible please park the vehicle undercover.

When you need to park for a long period (a month or more), you should make the following preparations:

- › Thoroughly wash and dry the bodywork.
- › Clean the inside of the vehicle to ensure it is clean and tidy.
- › Release the parking brake and apply chocks under the tyres.
- › Slightly open a side window (if parked undercover).
- › Pad the wiper blades with a folded towel or cloth so that they are not in contact with the windscreen.
- › To reduce sticking, silicone lubricants should be sprayed on all door seals.
- › Use covers made from porous material such as cotton to cover the vehicle. Nonporous materials such as plastic sheeting tend to build up moisture, which can damage the paintwork.
- › Disconnect the negative pole of the battery.
- › The vehicle should be kept in a ventilated environment with no hazardous or explosive materials.
- › Ensure the power battery charge is

above 50% (the power charge level display shows a charge of more than half).

- › The vehicle can be stored for less than 3 months at ambient temperatures between -20°C and 45°C; it can be stored for less than 6 months at ambient temperatures between 0°C and 45°C; if it is to be stored for more than 6 months, the ambient temperatures should be between 0°C and 35°C.

i NOTICE

It is recommended that you check the power battery charge monthly. If the “power battery charge low” light on the instruments cluster is on, charge the battery immediately.

Vehicle equipment

Please note that this manual describes all standard equipment, country-specific equipment and special equipment for this series. Therefore, some equipment or functions described in this manual may not be installed in your vehicle or only available in certain markets. To learn more about specific configurations, please refer to sales documents or consult the dealer where you purchased the vehicle.

Disposal of batteries and electronic equipment

Disposal of batteries

Do not dispose of used batteries (e.g. the vehicle battery and batteries in equipment such as the remote-control key and emergency call system) with your household waste. The symbol  reminds you of this.

Take these used batteries to a nearby recycling centre in accordance with local laws and regulations.

Disposal of electronic equipment

Electronic equipment marked with a symbol  (such as the navigation system's SD card or the radio remote control) must be kept and disposed of separately from ordinary household waste in accordance with the relevant laws and regulations.

Take this used electronic equipment to a nearby recycling centre in accordance

with local laws and regulations.

NOTICE

- › Delete any personal information that may be stored on the electronic equipment before disposing of it.
- › The batteries contained in used electronic equipment shall be previously taken out and disposed of separately.

Vehicle recycling and scrapping

Vehicle recycling

In order to protect the environment, we have already established procedures for vehicle recycling. Contact a local authorised service centre for information about vehicle recycling.

- › Recycling companies can recycle vehicles that comply with relevant national regulations for free.
- › After recycling, a recycling certificate will be issued, indicating that the scrapped vehicle was recycled according to environmental protection requirements.

Scrapping

When scrapping the vehicle or airbag system and seat belt pre-tensioner components, be sure to comply with relevant safety regulations. For more information, please consult authorised service centre.

7

Technical data

Vehicle identification..... 248

Vehicle parameters 250

Vehicle identification

Vehicle equipment

Please note that this manual describes all standard equipment, country-specific equipment and special equipment for this series. Therefore, some equipment or functions described in this manual may not be installed in your vehicle or only available in certain markets. To learn more about specific configurations, please refer to sales documents or consult the dealer where you purchased the vehicle.

Vehicle identification number

The vehicle Identification Number (VIN) is the identification code of the vehicle, it is unique and is engraved in the following positions:

- › On the left upper side of the dashboard.

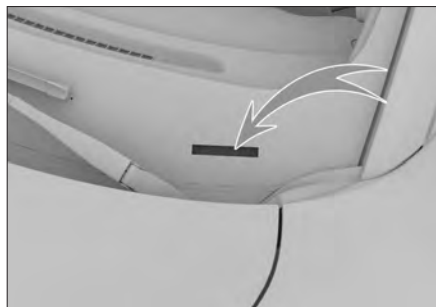

411AB41D39F6

- › On the cross member upon which the front right seat is mounted.



1035B4DA4E63

- › On the vehicle identification plate below the right C pillar catch.



47B1BD349905

i NOTICE

When a diagnostic tool is connected to the on-board diagnostic interface, you can read the vehicle identification number in the ECU.

Drive motor serial no.

TZ153XS001 motor

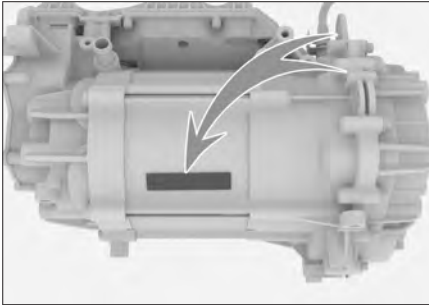

A37BDB0711D7

The drive motor serial no. is engraved on the housing in the position shown in the diagram.

Vehicle parameters

Basic parameters

For basic parameters such as overall vehicle dimensions, overall vehicle weight and maximum vehicle speed please see the official vehicle documents accompanying the vehicle.

CAUTION

All parameters set forth in this manual apply to vehicles with standard equipment, except if specifically mentioned or listed separately. Some of the parameters may differ for vehicles with special equipment and vehicles that are manufactured for other nations. The parameters described in the official vehicle documents that accompany the vehicle shall take precedence.

Powertrain parameters

Drive motor

| Model | Type | Maximum output rating (kW) | Peak torque value (Nm) | Maximum incline (%) |
|------------|------------------------------------|----------------------------|------------------------|---------------------|
| TZ153XS001 | Permanent magnet synchronous motor | 126 | 250 | 25 |

Power battery

| Model | Type | Rated voltage (V) | Rated capacity (Ah) | Operating temperature (°C) |
|-----------|--------------------------------|-------------------|---------------------|---|
| PB365131A | Lithium iron phosphate battery | 364.8 | 131 | -20 to 55 (charging) -30 to 55 (discharging) |
| PE338187A | Ternary lithium ion battery | 337.64 | 187 | -20 to 55 (charging) -30 to 55 (discharging) |

Tyre specification

| Item | | Data |
|----------------|-----------------------|--|
| Specifications | Standard tyres | 205/55 R17 95W, 215/50 R18 96V, 215/50 R18 92W |
| Tyre pressure | | See the tyre pressure label beneath the left front door lock |
| Snow chains | Specifications | Steel snow chains with maximum 12mm thickness or flexane snow traction devices (TPU Thermoplastic polyurethane) with maximum 15mm thickness. |
| | Installation position | Front wheels |

Wheel parameters

| Item | | Data | |
|----------------------------|-------------------|------------------------------|--|
| Dynamic balance parameters | Single side [g] | ≤ 8 | |
| | Bilateral sum [g] | ≤ 15 | |
| Alignment parameters | Rear wheels | Rear wheel camber | $-1^{\circ}30' \pm 30'$ (left-right deviation $\leq 30'$) |
| | | Rear wheel toe-in | $0^{\circ}7' \pm 15'$ (left-right deviation $\leq 15'$) |
| | Front wheels | King pin caster displacement | $4^{\circ}9' \pm 45'$ (left-right deviation $\leq 45'$) |
| | | Front wheel camber | $-0^{\circ}30' \pm 45'$ (left-right deviation $\leq 45'$) |
| | | Front wheel toe-in | $0^{\circ}6' \pm 5'$ (left-right deviation $\leq 5'$) |
| | | King pin camber | $11^{\circ}9'$ (for reference) |

Brake parameters

| Item | | Data |
|--------------------------------------|------------------------|------|
| Brake pedal | Free play [mm] | 4-7 |
| Front brake pads (friction material) | Minimum thickness [mm] | 2 |

| Item | | Data |
|-------------------------------------|------------------------|------|
| Rear brake pads (friction material) | Minimum thickness [mm] | 2 |
| Front brake disks | Minimum thickness [mm] | 20 |
| Rear brake disks | Minimum thickness [mm] | 10 |

Oil and fluid parameters

| Oil type | Specifications | Capacity (L) (reference value) |
|--------------------------------|---|---|
| Gearbox oil | Castrol BOT 352 B1 BEV | 0.74 ± 0.02 |
| Coolant (A/C, warm air system) | Ethylene glycol 35 (other than in extremely cold and high-altitude regions) | 2.1 ± 0.2 |
| Coolant (powertrain system) | Ethylene glycol 35 (other than in extremely cold and high-altitude regions) | 6.5±0.2 (left-hand drive) 6.7±0.2 (right-hand drive) |
| Brake fluid | DOT4 synthetic brake fluid | 0.72 ± 0.1 |
| Windscreen washer fluid | -- | 2.3 ± 0.2 |

i NOTICE

The oil and fluid volumes mentioned above are the designed values, actual consumption may vary slightly depending on such factors as the product, device and climate.

Seat parameters

| Item | | Data |
|------------------------------------|------------|--|
| Seat slide rail designed positions | | 20 mm movement forward from the furthest rear position |
| Designed seat back angle | Front seat | 25° |
| | Rear seat | 25° |
| Normal seat back angle | Front seat | 22°- 25° |
| | Rear seat | 25° |



Index

Alphabetical index..... 254

Alphabetical index

A

- A/C system 66
 - Intelligent cabin air refresh function 71
- Active intake grille 231
- Airbags
 - Curtain airbags 189
 - Front airbags 186,190
 - Seat-mounted side airbags 190
 - Side airbags 188
- Air pump and tyre repair fluid 213
- Anti-lock braking system 141

B

- Battery 231
- Battery safety switch 95
- Boot lid
 - Boot lid - manual 24
 - Electric sensor boot lid 25
 - Emergency release 28
- Bottle holder 76
- Brake fluid 230
- Brake parameters 251

C

- Charger warming or cooling 94
- Child locks 29
- Child restraint system 192
 - Child seat fixing points 194
- Coolant 230
- Cruise control assist system 123
- Cup holder
 - Front cup holder 75

D

- Data privacy and protection 207

- Disposal of batteries and electronic equipment 246
- Door lock
 - Super lock 23
- Door locks
 - Central locking and unlocking 22
 - Emergency locking 23
 - Intelligent entry system locking and unlocking 21
 - Internal release unlocking 23
 - Key button locking and unlocking 22
 - Mechanical key locking and unlocking 22
- Door window switch 31
- Drive motor serial no. 249
- Drive parameters 250
- Driving mode 106

E

- Electric parking brake 99
- Electric power steering 142
- Electric vehicle 92
- Electronic brake force distribution system 142
- Electronic stability control 142
- Emergency brake assist 142
- Emergency shut-off system 204
- Emergency tyre repair 213
- Energy recovery 94
- Engine compartment 229
- Engine compartment layout 229
- Event data recorder (EDR) 205
- Exterior maintenance 241

F

- Fuses 234

G

Gearbox 102

H

Headrests 46

Hill hold control 142

Horn 56

I

Instruments

Virtual instruments 144

Intelligent monitoring system 121

Interior care 242

K

Key 18

L

Lighting control

Lighting height adjustment 61

Lighting controls

Daytime running lights 61

Follow me home headlights function 61

Hazard warning lights 60

Lighting control combination switch 58

Vehicle interior 62

M

Mirrors

Side mirror ground view settings 54

Mobile phone wireless charging 72

P

Parking aid system

Panoramic view 113

Parking assistance system

Intelligent integrated parking system 115

Parking assist system

Anti-collision radar 114

Parking settings 112

Track-back reverse 117

Power assisted steering mode 110

Power battery recycling 91

Power management system 155

Power supply socket 76

R

Rear-seat occupant detection 202

Rear view mirror

Manual anti-glare rear view mirror 53

Run-in period 90

S

Seat belts 181

Seat parameters 252

Seats

Driver's seat memory 49

Easy entry function 49

Front row electric seats 48

Front row manual seats 46

Rear row seat adjustment 48

Seat settings 51

Secondary collision mitigation system 142

Side mirrors 53

Starting with jump leads 218

Steering wheel 56

Sunroof

Opening and closing the sunshade 35

Sunroof opening and closing 34

Sunroof care 240

Sun visors 74

T

Traction control system 142

Tyre care 238

Tyre inflation 215

Tyre pressure monitoring system 119

Tyre specifications 251

U

Ultrasonic theft protection system 201

V

Vanity mirror 74

Vehicle anti-theft system 199

Vehicle identification number 248

Vehicle power supply 97

Vehicle recycling and scrapping 246

W

Wheels parameters 251

Windscreen washer fluid 231

Windscreen wiper controls

Automatic wipers 63

Windscreen washer nozzle heating

function 65